

Marginal Cost of Service Study

PREPARED FOR



PREPARED BY

Philip Q Hanser

T. Bruce Tsuchida

Pearl Donohoo-Vallett

Lynn Zhang

Jens Schoene (EnerNex)

July 30, 2018



Table of Contents

Executive Summary	ii
I. Introduction.....	2
II. A More Granular MCCOS for the Con Edison System	4
A. Specific Calculation Methods Applied	8
B. MC Calculation and Cost Centers	14
1. Higher Voltage Cost Centers.....	14
2. Lower Voltage Cost Centers.....	16
C. Financial Assumptions	23
D. Calculated Marginal Costs	25
III. Grouping for the VDER Proceeding	34
A. Grouping by Drivers	34
B. Grouping Results.....	36
C. Applying the Grouping Results.....	38
IV. Conclusion and Recommendations	41
Glossary	43
Appendix-A: Wires Options – EnerNex Report	
Appendix-B: MC Calculation Example (Borough Hall Load Area)	
Appendix-C: Loaders	
Appendix-D: Grouping Approaches	
Appendix-E: Load Profile Clustering	
Appendix-F: Public Meeting Materials	

Executive Summary

The Brattle Group, Inc. (“Brattle”) and EnerNex LLC (“EnerNex”) were retained by the Consolidated Edison Company of New York, Inc. (“Con Edison”) to develop a Marginal Cost-based Cost of Service (“MCCOS”) study that identifies marginal costs (“MCs”) at the distribution network or feeder level (hereafter, referred to as the “Study”). Unlike previous MCCOS studies that provide MCs on a system-wide average value, this Study calculates MCs at the network/substation level granularity using projected costs and loads for the ten year period of 2018 through 2027.¹ While the Study was initiated by Con Edison in response to Rate Case Order 16 - E - 0060, the results will be useful for a number of applications, including supporting the Value of Distributed Energy Resources (“VDER”) proceedings. A more granular MC calculation will assist Con Edison evaluate the impacts of Distributed Energy Resources (“DERs”) on a locational basis, which may ultimately help the state of New York move towards achieve its Reforming the Energy Vision (“NY REV”) goals.

The Study calculates MC as the unit investment (in dollars per kilowatts, \$/kW) needed to accommodate incremental load growth. This unit investment is based on the net cost of incremental capacity resulting from the investment. Both the numerator (investment cost in \$) and denominator (capacity increase in kW) are incremental values. For example, if a 60 kW asset is added and a 50 kW asset of the same type is retired, the net investment cost is the cost of the 60 kW asset net of any salvage value of the existing 50 kW asset, and the incremental capacity is calculated as the difference between the load-serving capacity provided by the new 60 kW asset and the existing 50 kW asset.² To account for the difference in installation years, the Study converts the calculated MC values into net present values (“NPVs”). Potential investment options in this Study are purposely limited to traditional wires options.³ The Study results may be used as one of the metrics necessary for comparing the costs and benefits of various alternatives, including those of non-wires technology options.

The Con Edison distribution system consists of 84 systems (referred to hereafter as “Load Areas”), which includes 65 meshed (or networked) systems and 19 radial (or non-networked) systems, geographically covering the five boroughs of New York City—namely Manhattan (abbreviated as “M”), Brooklyn (“B”), Queens (“Q”), Bronx (“X”), Staten Island (“R”)—and Westchester county

¹ This Study relies on data and information that were available as of December 2017.

² The incremental capacity does not necessarily equal the nominal capacity (and is usually much smaller). This can be for various reasons, including how engineering planning process takes into account various contingencies to maintain system reliability, or how another element of the system could become the limiting factor after an investment.

³ Appendix-A: Wires Options – EnerNex Report to this report catalogues these traditional wires options and the general range of their costs observed.

(“W”) located directly north of New York City.⁴⁵ The Study calculates the MC for each of the 84 Load Areas over a ten year period of 2018 through 2027 for the following five cost centers:

1. High Voltage System Cost Center
2. Load Area Substation and Sub-transmission Cost Center
3. Primary Feeder Cost Center
4. Distribution Transformer Cost Center
5. Secondary Cable Cost Center

Investment needs, their timing, and location for the first two cost centers (“higher voltage cost centers,” namely the High Voltage System Cost Center and Load Area Substation and Sub-transmission Cost Center listed above) are taken from Con Edison’s “Area Substation and Subtransmission Feeder TEN-YEAR LOAD RELIEF PROGRAM” (“LRP”)—a long term investment plan.

Investment needs, their timing, and location for the other cost centers (“lower voltage cost centers,” namely the Primary Feeder, Distribution Transformer, and Secondary Cable Cost Centers listed above) are typically studied and identified only a year to a year and a half in advance and are not readily available for the entire ten-year Study period. The Study relies on historical samples from the past three years (2015 through 2017) to assess the investment costs and needs (timing) for the lower voltage cost centers on a Load Area basis. Historical samples are limited to the past three years. Older sample data may not adequately serve as a proxy for future costs nor serve usefully for assessing the timing of future investments as load growth has slowed significantly in recent years. To overcome the potential shortfall of sample data, the Study develops approximate costs by borough groups. Similarly, investment needs are assessed by observing the frequency of upgrades that occurred historically (e.g., on average, an upgrade was performed when peak load was anticipated to increase by 10 MW) and applying that frequency to the estimated future load (using the Load Area forecast load growth from LRP). Table 1: 2018 Average MC by Borough and Cost Center (\$/kW) summarizes the average 2018 MC by cost center and borough. The table shows lower voltage cost centers (Primary Feeder, Distribution Transformer, and Secondary Cable) represent a larger portion of the total MC. The table also shows higher MCs for the Distribution Transformer Cost Center for both Westchester and Staten Island. Systems in these two boroughs are largely radial and therefore are assumed to have less flexibility in meeting upgrade needs compared to the networked systems of the four other boroughs.⁶

⁴ While Westchester County is not a borough, for the purpose of grouping the Study will treat Westchester as equivalent to a borough and refer to it as one of the “six boroughs.”

⁵ There are two Load Areas in Westchester that were recently each split into two. 09W split from 01W (Washington Street) and 15W split from 10W (Granite Hill).

⁶ The Study assumes one upgrade in a network system will benefit other parts of the system (and therefore eliminate duplicate upgrade needs) while one upgrade in a radial system will not.

Table 1: 2018 Average MC by Borough and Cost Center (\$/kW)

Borough	Cost Center					Total
	High Voltage System	Load Area Substation and Sub-Transmission	Primary Feeder	Distribution Transformer	Secondary Cable	
M	0.00	0.94	20.21	3.08	35.72	59.95
X	0.00	0.00	49.42	0.00	10.13	59.55
B	0.00	9.02	63.60	38.46	19.12	130.20
Q	73.62	32.94	48.97	53.62	34.56	243.71
W	0.00	0.00	19.08	167.21	0.00	186.29
R	0.00	0.00	7.48	123.33	0.00	130.81

Note: Average MCs are weighted on forecasted 2018 load and are rounded to the nearest cent.

The 84 Load Areas are then aggregated into groups to develop Locational System Relief Values (“LSRVs”)—a metric to assist Con Edison in evaluating DERs at the distribution level (i.e., how much potential benefit a location may receive from DERs or other measures that reduce load growth). The Load Area groups can be used as a proxy for LSRV areas and their representative MCs as indicative for the LSRV. Observing that the upgrade needs are driven largely by the lower voltage cost centers, the grouping is done by looking at the two fundamental drivers that result in positive MCs:

- Cost data (developed by borough groupings for the lower voltage cost centers)
- Load growth forecast (in MW, rather than %) of the individual Load Areas taken from the LRP

These MC assessments are supplemented by additional measures identifying differences among Load Areas that should assist Con Edison in identifying preferred DER options (or other measures) for a particular Load Area. To help distinguish preferred DER options, the Study clusters the 84 Load Areas’ peak load day (in the summer) hourly load profiles into 3 distinct profiles, namely Flat Peak, Early Peak, and Late Peak, as shown in Figure 1: Load Profile Clusters.

Figure 1: Load Profile Clusters

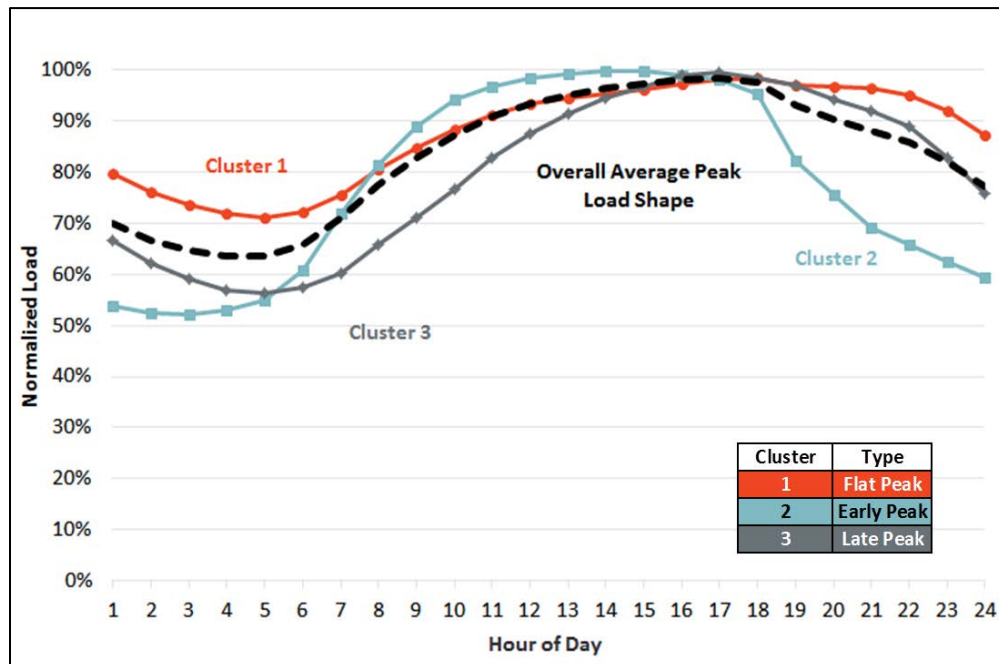

The clustered load profiles should help identify the most appropriate DERs for a particular location. For example, Load Areas with Early Peak load profiles (Cluster 2 shown in the teal line) may benefit the most from photovoltaic (“PV”) systems (or DERs with similar characteristics) because the load grows at dawn, peak is relatively flat during the hours when the sun is out, and further the peak drops around dusk just as the sun starts to set. On the other hand, Flat Peak load profiles (Cluster 1 shown in the red line) and Late Peak profiles (Cluster 3 shown in the grey line) may indicate that both load profiles may prefer a DER option that provides constant power throughout the day compared to Early Peak load profiles (Cluster 2 shown in the teal line). Load Areas with Late Peak load profiles (Cluster 3 shown in the grey line) may be able to take advantage of load shifting options more than Load Areas with Flat Peak load profiles (Cluster 1 shown in the red line) because of the larger difference in load levels between on-peak and off-peak hours.

Adding these load profiles as the third driver to the aforementioned two fundamental drivers (cost data represented through borough grouping and load growth data from the LRP), the Study groups the 84 Load Areas into six groups (“Aggregated Groups”). Figure 2: MC Summary by Groups below summarizes the MC of the six Aggregate Groups and system average (weighted by the projected Load Area peak loads) over the ten year Study period. The table within this figure

summarizes the three drivers (borough groupings indicating difference in cost assumptions, load growth, and load profile) for each Aggregate Group.⁷

Figure 2: MC Summary by Groups

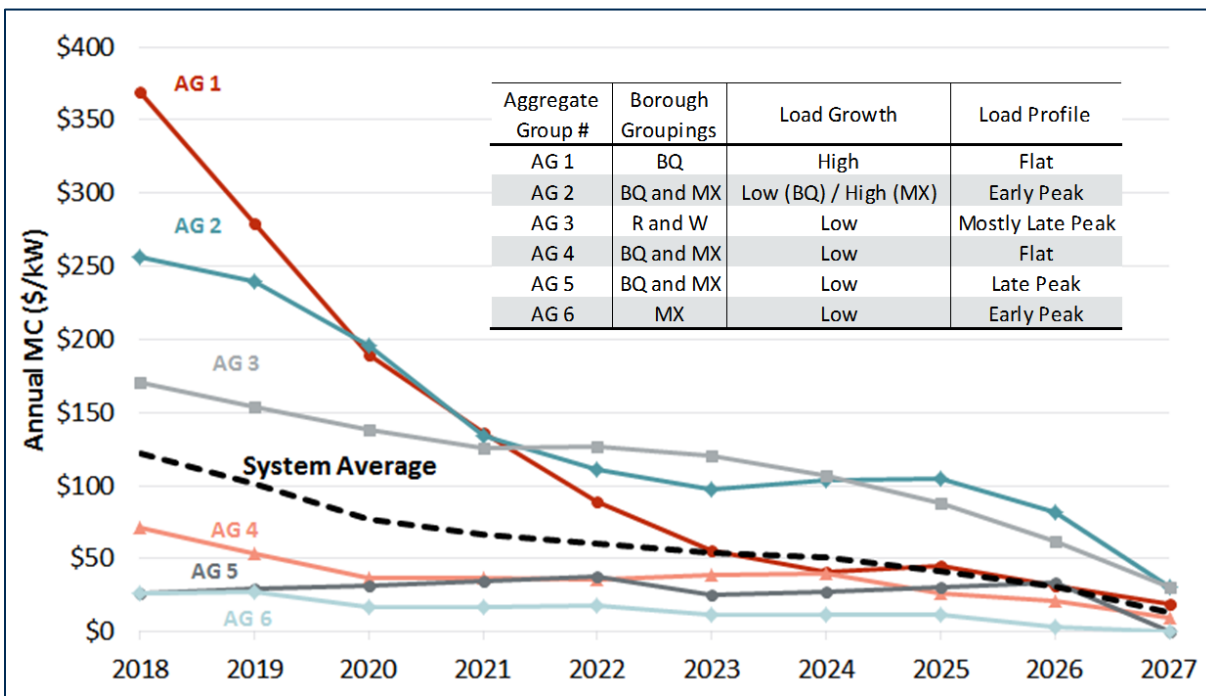

The figure identifies two Aggregate Groups (AG 1 shown in the red line and AG 2 shown in the teal line) to have MCs much higher than the system average in the early years, indicating potential to benefit more greatly from peak load reductions, a benefit DERs may provide. These two Aggregate Groups also include most of the Load Areas with higher load growth. All other Aggregate Groups (AG 3 shown in the light grey line, AG 4 shown in the pink line, AG 5 shown in the dark grey line, and AG 6 shown in the light teal line) have lower load growth. Among the low load growth Aggregate Groups, AG3 (shown in the light grey line) representing Load Areas with radial systems (Westchester and Staten Island) have higher MCs than the other Aggregate Groups with networked systems. This can be partially driven by the Study assumption used for the radial systems—that unlike network systems, one upgrade in a radial system will not offset another, leading to a larger number of upgrades needed.

Observations from this figure indicates that the second Aggregate Group (AG 2 shown in the teal line) with the Early Peak load profile may benefit from PVs or DERS with similar characteristics.

⁷ High load growth areas are defined as Load Areas where the cumulative ten-year load growth projection is larger than 20 MW. Low load growth areas are Load Areas where the cumulative ten-year load growth projection is smaller than 20 MW. Appendix-D: Grouping Approaches discusses this 20 MW threshold.

At the same time the grouping has identified that network system boroughs with low load growth (AG 4 through AG 6) will, on average, have MCs that are lower than the system average MC and perhaps not significantly benefit from peak load reduction.⁸ These observations, among others, can be used to value the benefits of DERs, including their location, as part of the VDER process.

Relying on MCs as one of the metrics to evaluate and determine LSRV areas and associated values requires caution. DERs, once installed, will likely be in service for over 20 years. MCs, on the other hand, are studied over a shorter time period (ten years in this Study) and rely on assumptions that are made at a much shorter horizon—for example the upgrade needs for lower voltage cost centers are studied and identified only a year to a year and a half in advance. This raises the question of whether MC values can be adequately translated to long-term payments. Even if relying on MCs is the best alternative, the MCs by themselves should not be translated directly as the LSRV. For example, the MCs for AG 1 include the Rainey-Corona Transmission Project with partial investments already made in 2016 and 2017. In calculating the 2018 MC, the Study adds the 2016 and 2017 costs to the 2018 costs so the total investment cost is not underestimated. Given the project's nature, even though the MCs are high, particularly in the earlier years, these investments are not as avoidable as other future projects and therefore the actual benefit of DERs may not be as high as the MC suggests. Another example may be the approximations and assumptions used for calculating the MCs. For the lower voltage cost centers, the Study uses cost estimates that are based on borough groupings. It assumes costs within these borough groupings for a given lower voltage cost center is uniform. On average this may be fine. However, in reality the costs may vary by location (even within the same Load Area) and applying one cost to all DERs may result in over or under compensation.⁹

In addition, the estimated reliability contribution from DERs needs to be considered and LSRVs adjusted for appropriately. The incremental load-serving capacity used for calculating the MCs for the traditional wires options is post-contingency capacity that may be further reduced based on system specific conditions. If these MC values are to be used as a guideline for evaluating the benefits of DERs, caution must be exercised in their use. For example, DERs' nameplate capacity may not truly reflect their capability to meet load at local system peaks. As a result, the level of reliability provided by the alternatives may not be directly comparable. Another reliability concern may be the future availability of the DERs. If DERs are awarded the avoided cost, will the DER be held responsible at the same level as the utility would for not performing in real time? Or will the DER have options to walk away without paying any penalty other than

⁸ AG3 represents Westchester and Staten Island where the system is largely radial and therefore the upgrade needs are higher

⁹ For example, assume the MC for a radial Load Area is the weighted average of two upgrade needs, one with a higher cost and the other with a lower cost. Compensating a DER that relieves the need for either of these upgrade needs with the average MC will end up in an under-pay (if the DER relieves the higher cost upgrade need) or over-pay (the DER relieves the lower cost upgrade need).

forgoing the agreed upon payment? And in such cases, will the utility be asked to provide a back-stop solution? These differences should also be taken into account when assessing the value DERs may provide.

Finally, as the figure shows, the MC is diminishing over time. The MCs for the six groups identified in this Study converge after five years, indicating the need for a speedy response should a policy (or incentive) to guide DER investments of the appropriate type to the preferred location is desired. It also illustrates the importance of refreshing the MCCOS study periodically and modifying such policies and/or incentives in a timely manner to match the updated MCCOS results. There are other considerations for periodically updating the MCCOS. The need of upgrades will continue to change as load profiles driven by the customers' usage pattern and load growth patterns evolve over time. As discussed earlier, the investments for the lower voltage cost centers are only studied and identified a year to a year and a half in advance. Costs will also change over time.¹⁰ The incremental cost information is quite lumpy and even if the same equipment is installed in two different locations within the same Load Area, both the incremental capacity and cost may vary by location and/or its application. For example, consider a simple project of replacing conduits on two radial systems that are both located within the same Load Area. Even if the same conduits were installed on both radial systems, their contribution to incremental load-serving capacity could vary because of the next binding distribution element that is unique to each location.¹¹ Similarly, the installation cost of identical conduits could vary by location.¹² As a result, there is typically a large range for MCs to vary within when one observes and compares past MCCOS studies.¹³ In general, the industry tries to reduce such impact by performing/updating MCCOS periodically.

In updating future MCCOS, there are several recommendations for improvements. The MC calculation—in incremental cost (\$/kW)—largely depends on available information from actual or planned projects. The data were relatively limited for this Study because of its being the first of its kind. In addition, the relative newness of the enterprise resulted in the required data not

¹⁰ Even if the equipment cost does not change, construction costs associated with installing the needed equipment can change—for example, the cost of digging up the streets in Manhattan 20 years ago and today are quite different.

¹¹ For example, assume the new cable segment has a capacity of 12, replacing an older cable that has a capacity of 8. If the rest of the sequential cables have a capacity of 10 for the first radial system and a capacity of 11 for the second radial system, the capacity contribution of the same cable will only be 2 for the first system but 3 for the second system.

¹² For example, the cost of two projects both installing identical cables of the same capacity could differ because one project has excess capacity in the existing duct from a previous project (due to the lumpiness of duct capacity) and thereby requiring no additional investments for the duct while the other does not have such excess capacity and installments of larger ducts are necessary.

¹³ The wide range of MCs can also be seen in Appendix-A: Wires Options – EnerNex Report that catalogues the traditional wires options and the general range of costs observed.

having been systematically collected to support such a study. Therefore, improving both the data quality and quantity (availability) for the various projects used to estimate the costs and frequency of upgrades in the future will lead to better MC calculations.¹⁴ Data collected over multiple years may also be used to estimate future costs—such as by observing a trend in costs over the year—rather than assuming historical prices will carry forward. Second, the Study assumes upgrades on networked systems can benefit all other parts of the network. However, this assumption may not necessarily be true in all instances, and therefore, would warrant further investigation. Third, the Study assumes zero salvage value for any asset that is being replaced. An internal review of the salvage values could improve the Study results. Similar to the cost estimates, data collected over multiple years can also be used to estimate future salvage values. Should this review be difficult, an alternative approach in calculating the MCs may be to simply assess the benefits of delaying the investment needs by one year. And finally, several Loaders that are sourced from the Embedded Cost Study should be updated once a new study becomes available.

The remainder of this report is organized as follows: Section I (Introduction) provides an overview and background of the Study; Section II (A More Granular MCCOS for the Con Edison System) discusses the calculation methodology, assumptions, and calculation results; Section III (Grouping for the VDER Proceeding) discusses the method and approach used for grouping the 84 Load Area by Load Area MCs, and finally Section IV (Conclusion and Recommendations) summarizes the findings and observations. A glossary is included at the end of the report.

Appendices include:

Appendix-A: Wires Options – EnerNex Report

Appendix-B: MC Calculation Example (Borough Hall Load Area)

Appendix-C: Loaders

Appendix-D: Grouping Approaches

Appendix-E: Load Profile Clustering

Appendix-F: Public Meeting Materials

All values are expressed in real 2018 dollars, unless quoted otherwise.

¹⁴ Increasing data samples may also be a challenge given the flat load growth being projected.

I. Introduction

This Study develops a MCCOS that identifies MCs at the distribution network or feeder level for Con Edison. The Study was developed in collaboration with Con Edison staff, the New York State Department of Public Service (“DPS”) staff, and involved several public stakeholder meetings.¹⁵

Previous MC studies provide system-wide average values and the purposes for which these studies are used typically do not require location-specific measures. With today’s changing environment that includes various types and applications of DERs, some regulators are now moving towards requiring distribution utilities to provide location-specific MC studies. The New York Public Service Commission (“Commission”) is no exception and has indicated that a more granular approach may be needed to support the NY REV goals.¹⁶ This Study determines MCs at differing levels of network-level granularity for the ten year period of 2018 through 2027.¹⁷ While this Study was commenced by Con Edison in response to Rate Case Order 16-E-0060, the Study results—granular locational MCs—can be used for a variety of purposes, including supporting New York’s Value of Distributed Energy Resources (“VDERs”) Proceedings, which is part of the Commission’s approach towards achieving the NY REV goals. Specifically, the Study may help Con Edison set values for multiple Locational System Relief Value areas (“LSRVs”) based on the granularly calculated MCs.¹⁸

¹⁵ Materials from these meetings are included in Appendix-F: Public Meeting Materials.

¹⁶ The Order is available at:

<http://documents.dps.ny.gov/public/Common/ViewDoc.aspx?DocRefId=%7b5B69628E-2928-44A9-B83E-65CEA7326428%7d>

Additional materials for the case is available at:

<http://documents.dps.ny.gov/public/MatterManagement/CaseMaster.aspx?MatterCaseNo=15-E-0751>

¹⁷ The standard industry practice is to perform the calculation over a pre-defined period, such as the ten year period assumed for this Study. Con Edison’s prior marginal cost study also covers a ten year horizon.

¹⁸ The Commission has instructed NY State utilities to de-average the current marginal cost studies for the purposes of the VDER Proceeding. Con Edison previously only calculated marginal costs on a system-wide basis. In order to apply the single marginal cost value to indicate the potential benefits of DERs among these varying areas, Con Edison “stretched” (i.e. applied a multiplier that is larger than one) this single value in high benefit areas and “squeezed” (i.e. applied a multiplier that is less than one) this single value in low benefit areas. The “stretch” and “squeeze” was done so that the weighted average value equaled the single marginal costs value. The granular MC calculation can replace these “stretched and squeezed” values for the VDER Proceedings.

The Study focuses on the traditional wires options and provides a baseline for other non-wires solution to be compared against.¹⁹ Separate cost-benefit analyses can then be performed for the various non-wires solutions as needed.²⁰

¹⁹ The Study relies on Con Edison's load forecast to identify when investments are needed. Con Edison's load forecasts do reflect (as load modifiers) non-wires options that exist today or future projects that are included in the Con Edison planning.

²⁰ With the myriad of technology options available today, it is impractical to evaluate and reflect all technology options as part of the Study.

II. A More Granular MCCOS for the Con Edison System

The Con Edison distribution system consists of 84 Load Areas geographically spanning over the five boroughs of New York City—Manhattan (abbreviated as “M”), Brooklyn (“B”), Queens (“Q”), Bronx (“X”), Staten Island (“R”)—and Westchester County (“W”) located directly north of New York City, as shown in the blue shaded areas in Figure 3: Con Edison Service Territory below.²¹ While Westchester County is not a borough, it will be referred to as a “borough” in this Study, and therefore the Study describes the Con Edison service territory to geographically span over six “boroughs.” The Study calculates the MC by Load Areas for the 84 Load Areas over the ten year period of 2018 through 2027.

Figure 3: Con Edison Service Territory



Out of the 84 Load Areas, 65 are meshed or networked systems and 19 are radial (non-networked) systems. Figure 4: Distribution System Sketch below illustrates the components (primary feeders, transformers, and secondary cables) that comprise a Load Area, and the concept of network and radial systems. The area station (indicated by the grey square labeled Area Station) is the highest level within a distribution system (i.e., Load Area) and connects to the transmission system (indicated by the light blue line labeled 138 kV Feeder). Each distribution system (Load Area) will have primary feeders (indicated by the red lines), transformers (indicated by the black triangles), and secondary cables (indicated by the green dotted lines). The distribution system may be a networked system (shown in the left hand side of the figure, labeled

²¹ Source: http://media.corporate-ir.net/media_files/nys/ed/10k/Financial10K2005ED.htm

Underground Primary Feeder), or a radial system (shown in the right hand side of the figure, labeled Overhead Primary Feeder).²² As this figure shows, a load (indicated by either a green or purple square) on a networked system can be served through multiple paths while a load on a radial system can only rely on one path (hence radial). This indicates an important difference between the two network types—e.g., load reduction in a networked system will benefit other segments of the network while those on a radial system will only serve the specific radial system.²³ This distinction is reflected into the MC calculations.

Figure 4: Distribution System Sketch

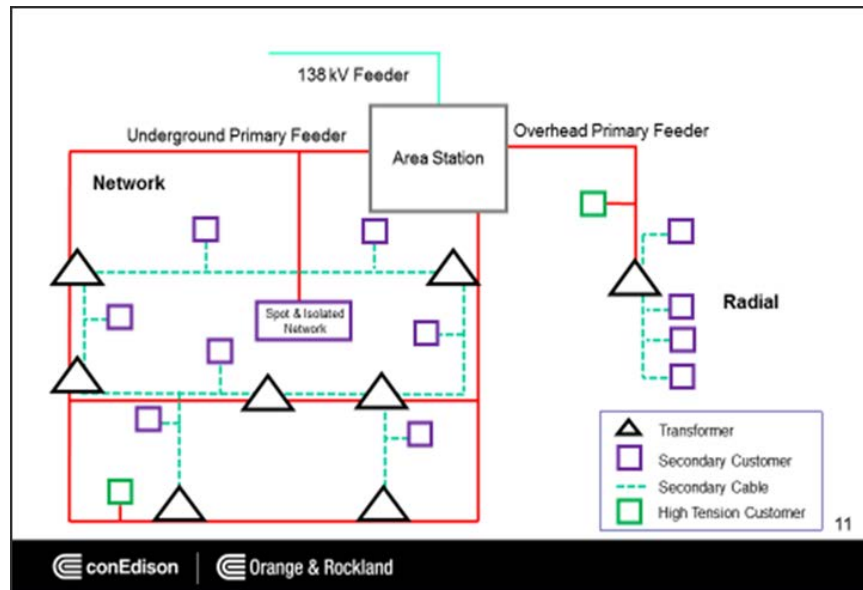

Source: Con Edison.

²² The physical difference in network, i.e., underground vs. overhead, does not necessarily translate one to be meshed/networked vs radial. This figure should be understood as an illustrative example.

²³ MCs represents the value of delaying (or avoiding) the investments by one year. A potential investment needed in a network system can be delayed/avoided by a load reduction in any part of that network while a potential investment needed in a radial system can only be delayed/avoided by a load reduction in that specific part of the system. Similarly, investments that are common to multiple Load Areas can be delayed/avoided by load growth reduction in any of the relevant Load Areas.

Tables 2a through 2f below list the 84 Load Areas by borough along with their network type (i.e., network vs radial) and peak load observed in 2016.

Table 2a: Manhattan Load Areas

Load Area Code	Load Area	Load Area Type	2016 Load (MW)
01M	Washington Heights	Network	192
02M	Harlem	Network	200
03M	Yorkville	Network	296
04M	Grand Central	Network	187
05M	Times Square	Network	147
06M	Madison Square	Network	244
07M	Cooper Square	Network	255
08M	City Hall	Network	137
09M	Hunter	Network	71
10M	Sheridan Sq.	Network	168
11M	Plaza	Network	149
12M	Empire	Network	59
13M	Chelsea	Network	220
14M	Randall's Island	Network	23
15M	Cortlandt	Network	59
16M	Pennsylvania	Network	160
17M	Central Park	Network	221
18M	Battery Park City	Network	70
19M	Rockefeller Center	Network	81
20M	Sutton	Network	135
21M	Columbus Circle	Network	137
22M	Canal	Network	109
23M	Lincoln Square	Network	152
24M	Lenox Hill	Network	252
25M	Turtle Bay	Network	108
26M	Greeley Square	Network	60
27M	Fulton	Network	98
28M	Herald Square	Network	99
29M	Beekman	Network	124
30M	Fashion	Network	68
31M	Roosevelt	Network	76
32M	Greenwich	Network	59
34M	Park Place	Network	83
39M	Hudson	Network	60
40M	Bowling Green	Network	105
41M	Freedom	Network	26
43M	Kips Bay	Network	111
44M	Triboro	Network	141
53M	Midtown West	Network	80

Table 2b: Brooklyn Load Areas

Load Area Code	Load Area	Load Area Type	2016 Load (MW)
01B	Borough Hall	Network	287
02B	Park Slope	Network	219
03B	Crown Heights	Network	207
04B	Flatbush	Network	281
05B	Ridgewood	Network	199
06B	Williamsburg	Network	287
07B	Ocean Parkway	Network	172
08B	Bay Ridge	Network	243
09B	Richmond Hill	Network	340
10B	Sheepshead Bay	Network	173
11B	Brighton Beach	Network	103
12B	Prospect Park	Network	63

Table 2c: Queens Load Areas

Load Area Code	Load Area	Load Area Type	2016 Load (MW)
01Q	Long Island City	Network	218
02Q	Borden	Network	115
03Q	Rego Park	Network	241
05Q	Jamaica	Network	468
06Q	Maspeth	Network	263
07Q	Flushing	Network	383
09Q	Jackson Heights	Network	189
10Q	Sunnyside	Network	84

Table 2d: Bronx Load Areas

Load Area Code	Load Area	Load Area Type	2016 Load (MW)
01X	Riverdale	Network	99
02X	West Bronx	Network	220
03X	Fordham	Network	260
04X	Central Bronx	Network	183
05X	Northeast Bronx	Network	112
07X	Southeast Bronx	Network	219

Table 2e: Westchester Load Areas

Load Area Code	Load Area	Load Area Type	2016 Load (MW)
01W/09W	Washington Street	Radial	211
02W	Rockview	Radial	98
06W	Ossining West	Radial	75
07W	Millwood West	Radial	87
08W	White Plains	Radial	250
10W/15W	Granite Hill	Radial	223
11W	Pleasantville	Radial	84
12W	Elmsford No. 2	Radial	177
13W	Buchanan	Radial	127
17W	Harrison	Radial	240
19W	Grasslands	Radial	115
20W	Cedar St	Radial	107

Table 2f: Staten Island Load Areas

Load Area Code	Load Area	Load Area Type	2016 Load (MW)
01R	Fresh Kills	Radial	204
02R	Fox Hills	Radial	212
03R	Wainwright	Radial	92
04R	Willowbrook	Radial	87
05R	Woodrow	Radial	117

A. SPECIFIC CALCULATION METHODS APPLIED

MC calculations look at the incremental investment needed to accommodate load growth and try to identify the least cost means of meeting an increase in demand without jeopardizing the current level of reliability.²⁴ There are three fundamental questions:

1. How much is the investment cost (in \$/kW)?
2. When will the investment be needed (i.e., what year, within the ten year Study horizon)?
3. Where will it be needed (to assess the marginal cost at the appropriate granularity level)?

To answer these three questions, MCCOS begins by identifying and reviewing the cost and timing of the investments (addressing the first two questions listed above). The nature of the cost and timing of these investments (defined by the physical nature of the equipment used for the

²⁴ This is done by conforming to the utility’s design standard. There is no practical way to guarantee the level of reliability.

electric power systems—i.e., they are typically large in size and have varying economic life-spans) drives the overall MC calculation method. First, investment costs (from the first question) are annualized to include their economic carrying charge and fixed O&M expenses. Then, to account for the different timing of the investment needs (second question) the annualized costs are converted into Net Present Values (“NPV”s).²⁵ The need for higher locational granularity introduces the third question of “where.” While there are various levels of locational granularity, the Study calculates the MC on a Load Area by Load Area basis.²⁶ Details of the steps identifying the cost and timing of the investments are discussed next.

The Difficulty of Cost Assessments

MC calculation focuses specifically on the investment needs to accommodate incremental load growth and not on any other investment needs—for example, replacing an existing asset because of its age, or the cost of interconnecting a new customer, such as a newly developed commercial complex, should not be accounted for as part of the MC calculation. However, costs for projects to accommodate new load, such as increasing the capacity of existing equipment so the new load can be interconnected without impacting the reliability of existing loads, should be included in the MC calculation. The two distinct purposes associated with new loads may be recorded under one project, leading to the need for separating the project costs so it can appropriately be applied to the MCCOS. Oftentimes equipment and labor costs associated with such projects are difficult to separate precisely by purpose, leading to some assumptions and approximations. The “lumpiness” of asset size leads to even more cost approximations because one cannot increase the system capacity on a strictly marginal basis—all assets have certain capacities and cannot be purchased in 1 kW increments. In addition, economies of scale are observed in these assets and typically larger equipment exhibit lower unit costs. This “lumpiness” leads to further difficulties in assessing the appropriate costs for the electricity system that can comprise a number of different equipment that all impact each other—for example, the cost of two projects that are both installing identical conduit of the same capacity could differ because one project had excess capacity in the existing duct from a previous project (due to the lumpiness of duct capacity) and thereby requiring no additional investments for the duct while the other did require new ducts. All in all, it should be understood that cost estimates are not as easy as one may imagine, and may contain many approximations.

²⁵ NPV calculation can also potentially address varying lengths of the investments’ economic life span, which may vary much more in the future. This approach renders that the size and type of investment may not be as important, unless the information is needed for corollary purposes.

²⁶ In addition, location helps with assessing the investment costs through clustering when ample data is not available.

MC calculation focuses specifically on the investment needs to accommodate incremental load growth. Naturally, investments to accommodate the incremental load growth, in many cases, require replacing the same asset type—retiring an existing asset with smaller capacity that still has usable life and adding a new larger asset of the same type. The existing asset would not have to be upgraded if it weren't for the load growth. Therefore, this Study assumes the proper cost to use is the incremental (or net cost of) investment—i.e., the cost of the new investment net of the salvage value of the asset that is being replaced/retired to accommodate the increase in load—rather than the entire cost of the new asset. Investments that do not replace any assets (i.e., projects that only include new assets) will have no salvage values. Con Edison does repurpose certain assets, such as transformers, so there are positive salvage values. However, at the time of the Study, there is insufficient sample information for the salvage value estimates and therefore the Study conservatively sets salvage values to zero (subject to future updates).²⁷

Similarly, the Study uses incremental load serving capacity (or net capacity)—i.e., the load serving capacity of the new asset net of load serving capacity of the asset that is being replaced/retired—for the MC calculation.²⁸ This load serving capacity does not necessarily match the nameplate capacity of the assets, and oftentimes is adjusted to be smaller. Such capacity adjustment occurs largely for two reasons. First is to comply with the existing reliability requirements by conforming to the utility's design standards. For example, engineering planning of the electric power system accounts for contingency conditions and therefore requires redundancy to be included in the system. Therefore, the load serving capacity rating is usually based on post-contingency capacity, which is smaller than the nominal capacity. Second, not all capacity of a given asset will contribute to the capacity increase needs for accommodating load growth. This can be for several different reasons. Investments to accommodate load growth may be optimized together with investments for other purposes. In such cases, the combined capacity must be properly allocated between the two different purposes. It can also be because of the physical system and lumpiness of investment options. Upgrading one section of the system by a given quantity does not necessarily mean that the entire system capacity has been bolstered by the same amount.²⁹ The Study relies on Con Edison engineers to determine the incremental load serving capacities, where applicable.³⁰

²⁷ If the salvage value data was known not to be available, an alternative, and perhaps simpler, approach in calculating MCs may have been to assess the benefits of delaying the investments by a year. In such case, the denominator (capacity) for the investment cost (\$/kW) also does not need to be adjusted. Therefore the investment cost (\$/kW) will simply be the total cost (\$) divided by the total load-serving capacity of the new asset (kW).

²⁸ The load serving capacity kilo-watts (kW) reflect only active power (i.e., real power and not reactive power.) In many cases, utility equipment is measured in apparent power units, or kilo-volt-amperes (kVA). kVA units are converted to kW using relevant power factors.

²⁹ An easy illustrative example may be upgrading assets in series. Assume a radial system with two cable segments installed in series. The first segment has a capacity of 8, the second segment has a capacity of

Continued on next page

The investment cost (in \$/kW) calculated using incremental values for both the numerator and denominator—investment costs (net of salvage value) as the numerator and incremental capacity (net of existing asset capacity) as the denominator—is then annualized.³¹ Finally, to account for the different timing of investments, the NPV of the annualized investment costs are calculated. Figure 5: Annualizing Investment Costs below shows the process for annualizing the investment costs. Table 3: Parameters Used for Annualizing Investment Costs summarizes the values of the various parameters shown in Figure 5. Details on the parameters included in Table 3 are discussed later in Section I.C: Financial Assumptions.

Figure 5: Annualizing Investment Costs

Annualize and Load

$$\begin{aligned}
 \text{Total Annualized Cost} &= \text{Annual Investment Cost (incl. G\&A)} + \\
 &\quad \text{O\&M (incl. G\&A)} + \text{Revenue Requirement for Working Capital} \\
 &\quad \text{(incl. G\&A)} \\
 &= \\
 &\quad \text{Investment Cost} \times \text{Economic Carrying Charge} \times (1+\text{Plant G\&A}) \times \\
 &\quad (1+\text{Common Plant}) \\
 &\quad + \\
 &\quad \text{Investment Cost} \times \text{Historical O\&M per \$ Cost Center} \times (1+\text{Non-} \\
 &\quad \text{Plant G\&A}) \\
 &\quad + \\
 &\quad \text{Investment Cost} \times \text{Revenue Requirement for Working Capital} \times \\
 &\quad (1+\text{Plant G\&A}) \times (1+\text{Plant Loading}) \times \text{Working Capital/Total Plant} \\
 &\quad \times \text{Return Rate}
 \end{aligned}$$

Continued from previous page

10, and upgrade options for the first segment is only available in incremental capacities of 3. In this example, upgrading the first cable segment by 3 (from a capacity of 8 to 11) will only enhance the system’s capacity by 2, not by 3.

³⁰ The Study did not verify the information and data received from the Con Edison engineers.

³¹ The Study annualizes costs over a ten year period, which matches the Study period. While many assets’ economic lives could be longer than ten years, there is no guarantee that any asset will serve through its economic life (for example, upgrades may be needed to accommodate additional load growth) and further using a longer period to calculate the NPV may dilute the MC calculation.

Table 3: Parameters Used for Annualizing Investment Costs

Varies Across Equipment and Application	
Plant A&G Costs	0.00% - 0.07%
Cost Center O&M	2.37% - 3.05%

Common Across Equipment and Application	
Inflation Rate	3.00%
Common Plant %	7.59%
Economic Carrying Charge	9.67%
Working Cap as % of Electric PIS	2.65%
Income Tax Rate	6.19%
Regulated WACC	9.59%
Non-Plant A&G	3.66%
Revenue Requirement for Working Capital	15.78%

Figure 6: Illustrative Calculation Example below describes the four steps discussed above through an illustrative example. In this example, a new 238 MW asset is installed in 2021 and replaces an existing 167 MW asset. The cost of the new asset is \$1.6 million (in 2021) and the salvage value of the existing asset is assumed to be zero.

Figure 6: Illustrative Calculation Example

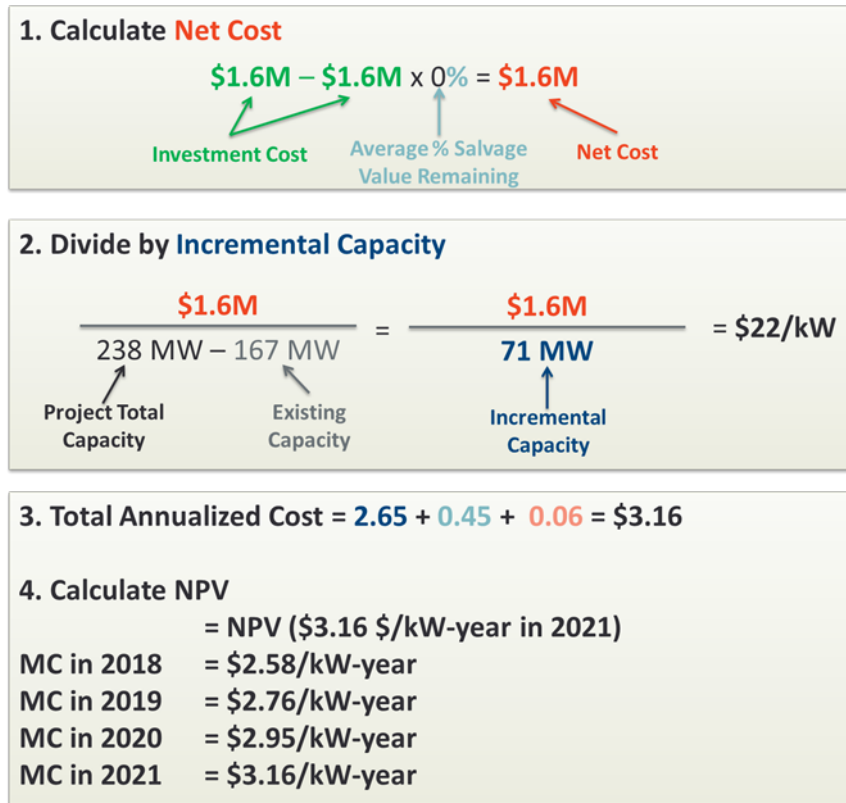

Step 1 calculates the net investment cost (net of salvage value, which is assumed zero) that occurs in 2021. Step 2 divides the net investment cost calculated in Step 1 by the incremental capacity increase and derives the incremental investment cost. Step 3 annualizes the incremental investment costs using the formula shown in Figure 5. The total annualized cost is the sum of Annual Investment Cost (in navy text), O&M (in teal text), and Revenue Requirement for Working Capital (in red text), all including G&A costs. Step 4 calculates the NPV of the annualized investment costs that occurs in 2021 by year.³² These values are the avoidable costs by year for this investment—or in other words, the value of reducing a kW of load growth in 2018 is worth \$2.58/kW. An important note here is that the calculations do not show any value for 2022 and after in this example. This is because of the lumpiness of the investment—i.e., once the investment is made in 2021, no more upgrades are needed until the aggregated load growth outgrows the excess capacity provided by the 71 MW investment (i.e., aggregated load growth exceeds 71 MW), and in the meantime the MC drops to zero.

³² For investments that have different timings, such as investments in 2018 and 2019 for an asset that is put into service in 2020, the NPV calculation is performed prior to annualizing the investment costs.

B. MC CALCULATION AND COST CENTERS

The Study calculates MCs on a Load Area by Load Area basis for the following five cost centers with costs properly allocated among Load Areas.

1. High Voltage System Cost Center
2. Load Area Substation and Sub-transmission Cost Center
3. Primary Feeder Cost Center
4. Distribution Transformer Cost Center
5. Secondary Cable Cost Center

The first cost center, High Voltage System, is defined as any asset that is upstream of the area substation (Load Area level) and includes the transmission system (excluding transmission congestion contracts) and switching stations.³³ Investments in this cost center bridge over multiple Load Areas and are assigned appropriately to the relevant Load Areas. Costs for the remaining four cost centers are generally assigned to unique Load Areas and do not need to be split.³⁴ However, the cost calculation application may vary by Load Areas, or even within a Load Area. An investment in a networked system is assumed to reduce/delay the need for further investment elsewhere in the same system while an investment in a radial segment of a system is assumed it will not help other segments of the system reduce/delay future investments. Therefore the impact of investments on radial systems (or segments of) can be locationally limited compared to those for networked systems (or segments of). This difference changes how one may account for a given Load Area and its component by their network type.

Detailed calculation approaches for each of these five cost centers are discussed next. For discussion purposes, the five cost centers are grouped into two—the higher voltage cost centers, namely first two cost centers (High Voltage System, and Load Area Substation and Sub-transmission), and the lower voltage cost centers, namely the last three cost centers (Primary Feeders, Distribution Transformer, and Secondary Cables). Appendix-B: MC Calculation Example (Borough Hall Load Area) walks through the Borough Hall Load Area actual MC calculation for all five cost centers.

1. Higher Voltage Cost Centers

The higher voltage cost centers include both the High Voltage System Cost Center, and Load Area Substation and Sub-transmission Cost Center. Con Edison's "Area Substation and Subtransmission Feeder TEN-YEAR LOAD RELIEF PROGRAM" ("LRP") is a long term

³³ In the previous Con Edison MC study, the High Voltage System cost center was further divided into three cost centers—Transmission (excluding transmission congestion contracts), Switching Station – Transmission functionality, and Switching Station – Substation functionality.

³⁴ Exceptions include Area Stations that are common among Load Areas.

investment plan study that identifies upgrade needs for area stations and higher voltage level assets, effectively covering the first two cost centers with higher voltage equipment over a ten year period.

For the High Voltage System Cost Center, the only investment identified in the LRP is the Rainey-Corona Transmission project. The investment cost of this project is assigned to the relevant five Load Areas—namely Long Island City (01Q), Rego Park (03Q), Jamaica (05Q), Flushing (07Q), and Jackson Heights (09Q).³⁵ Investments in this project bridges over a four year period of 2016 through 2019, with two years (2018 and 2019) remaining as of the time of the Study. For this Study, investment costs incurred in 2016 and 2017 are added to the 2018 investment schedule, in order to avoid potential underestimation of the overall project cost.

Similarly, investments needs, timing, and location for the Load Area Substation and Sub-transmission Cost Center relies on the LRP. Table 4: Load Area Projects Identified in the LRP lists the upgrade needs and associated costs by Load Area, as identified in the LRP. As this table shows, several Area Station projects (e.g., Water St and Corona No. 2) are common among Load Areas.

³⁵ The full cost is assigned to each of the five Load Areas because reduction in any of these five Load Areas could theoretically delay/avoid the investment. However, the investment has been ongoing and delaying the remaining investment because of reduction in load growth may not be practical.

Table 4: Load Area Projects Identified in the LRP

Load Areas with LRP Projects			Project Data			
Load Area Code	Load Area	Area Station	Cost Center	Online Year(s)	Total Capacity Increase (kW)	Total Cost (\$ thousand)
01B	Borough Hall	Plymouth St	Load Area Substation and Sub-transmission	2019, 2020	67,000	19,037
06B	Williamsburg	Water St	Load Area Substation and Sub-transmission	2019	74,000	12,758
12B	Prospect Park	Water St	Load Area Substation and Sub-transmission	2019	74,000	12,758
01Q	Long Island City	North Queens	High Voltage System	2019	236,000	151,793
02Q	Borden	Newtown	Load Area Substation and Sub-transmission	2027	116,000	74,947
03Q	Rego Park	Corona No. 2	High Voltage System	2019	236,000	151,793
05Q	Jamaica	Jamaica	High Voltage System	2019	236,000	151,793
06Q	Maspeth	Glendale	Load Area Substation and Sub-transmission	2021	192,000	188,806
07Q	Flushing	Corona No. 1	High Voltage System	2019	236,000	151,793
09Q	Jackson Heights	Corona No. 2	High Voltage System	2019	236,000	151,793
10Q	Sunnyside	Newtown	Load Area Substation and Sub-transmission	2027	116,000	74,947
11M	Plaza	West 65th St No. 1	Load Area Substation and Sub-transmission	2025	56,000	11,584

2. Lower Voltage Cost Centers

Investment needs for the three lower voltage cost centers—Primary Feeders, Distribution Transformers, and Secondary Cables (everything below the area substation level in Figure 4: Distribution System Sketch discussed earlier)—are typically studied and identified only a year to a year and a half in advance. Therefore, the Study relies on historical data to estimate future costs and investment timing. This analysis is performed on a cost center basis through two distinct steps: first assessing the investment cost, and second assessing the investment timing and location.

Investment Cost Estimates for the Lower Voltage Cost Centers

Investment costs for the lower voltage cost center are assessed by observing historical project samples from the past three calendar years (2015 through 2017). Sample data are limited to projects accommodating the increasing load from customers and not those associated with other purposes, such as replacing aging equipment or reinforcing the system. This distinction can lead the sample data collecting process to be one that is much more involved because oftentimes

projects are not dedicated solely to address load growth but optimized with other purposes. For this Study historical sample data comprise those from Con Edison's Load Relief data and New Business data from 2015-2017 (inclusive), where possible.³⁶ The sample data is limited to the past three years to maintain consistency within the cost data used—i.e., older data may not reflect the cost of today and therefore may not be as adequate to use as a proxy of future costs for calculating MCs.³⁷ However, limiting historical data to three years does have drawbacks, including the sample size potentially not being comprehensive enough to assess future costs for all Load Areas, and the small sample size magnifying the lumpiness issue of investment. To account for this data insufficiency, historical cost sample data is grouped by boroughs. Grouping by boroughs aligns well with the cost difference observed in Con Edison's existing contracting costs—i.e., the contract costs are determined by the “difficulty” to install new equipment or replace older equipment, such difficulty is higher in urban areas, and urbanization is one strong characteristic in distinguishing the six boroughs.³⁸ Table 5: Sample Data Summary summarizes the range of years from which historical project sample were taken, by borough, cost centers, and the two data sources. An N/A indicates no data was available.

³⁶ While most Load Relief projects is for accommodating incremental load, the New Business projects include both upgrades needed to accommodate incremental load growth and investment needed specifically to interconnect the new load. Distinction between these two New Business project types is necessary because the latter should not be part of the MC calculations.

³⁷ Historical costs may not be representative of future costs due to the integration of DERs. Another example may be the cost of construction to bury cables in New York City where Con Edison serves. Such cost is likely much higher today than it was 20 years ago.

³⁸ An easy example may be the difficulty of setting up cranes for construction and digging the streets in urban Manhattan vs. suburban Staten Island. In Manhattan, delivery of larger equipment and detouring traffic to allow for construction may be limited to night time only when traffic volume is lower while suburban areas may allow more flexibility.

Table 5: Sample Data Summary

Cost Center	Borough					
	M	X	B	Q	W	R
Load Relief Data						
Primary Feeders	2015-2017	2015-2017	N/A	2015-2017	2015-2017	N/A
Secondary Cables	2015-2017	2015-2017	2015-2017	N/A	N/A	N/A
Distribution Transformers	2015-2017	2015-2017	2015-2017	2015-2017	2015-2017	N/A
New Business Data						
Primary Feeders	2015-2017	2015-2017	N/A	N/A	2015-2017	N/A
Secondary Cables	2016	2016	2016	2016	N/A	N/A
Distribution Transformers	2016-2017	2016-2017	2016-2017	2016-2017	N/A	N/A

Table 6: Count of Samples by Borough and Cost Center below counts the sample projects available by cost center and borough for the three lower voltage cost centers.

Table 6: Count of Samples by Borough and Cost Center

Cost Center	Borough	Network				Radial		Total
		M	X	B	Q	W	R	
Primary Feeders	Unique Projects	15	6	0	2	19	0	42
	Unique Load Areas	13	4	0	2	6	0	25
Secondary Cables	Unique Projects	31	19	11	8	0	0	69
	Unique Load Areas	24	6	10	8	0	0	48
Distribution Transformers	Unique Projects	4	7	21	10	74	0	116
	Unique Load Areas	4	4	8	6	12	0	34
Total	Unique Projects	50	32	32	20	93	0	227
	Unique Load Areas	41	14	18	16	18	0	107

As Table 6: Count of Samples by Borough and Cost Center above shows, not all boroughs and cost centers have sufficient sample counts—for example, there are no Primary Feeder sample data for Brooklyn (B) and Staten Island (R). To account for this data insufficiency, boroughs are further combined into borough groups, based on the similarity of costs and network configuration characteristics (network vs. radial). Table 7: Borough Groupings shows these groupings.

Table 7: Borough Groupings

Borough	Borough Abbreviation	Borough Group
Manhattan	M	M/X
Bronx	X	M/X
Brooklyn	B	B/Q
Queens	Q	B/Q
Westchester	W	W
Staten Island	R	R

The small sample size also magnifies the issue associated with the lumpiness of investments. For example, there may have been a period for a given Load Area when no upgrades were needed because of a significant upgrade that took place right before the sampled time frame. Or the historical samples may include one or two counts of such atypical large investments. To identify and account for these outliers, the historical sample cost data grouped into boroughs is plotted and observed to see the variation among the individual samples. Figure 7: Sample Data Distribution – Primary Feeders shows the cost per incremental capacity of all Primary Feeder samples listed in Table 6: Count of Samples by Borough and Cost Center. While many of the samples for Westchester (marked W, shown in grey triangles) and Queens (marked Q, shown in teal squares) appear relatively concentrated, some samples for Manhattan (marked M, shown in navy diamonds), and Bronx (marked X, shown in red circles) can be seen as outliers. To account for these potential outliers, the Study compares the Median, Mean, and Weighted Mean values by cost center and borough, as shown in Table 8: Mean, Median, and Weighted Mean Values of Sample Data, and uses the Weighted Mean (Mean weighted by the project capacity increase) values as the representative cost for each cost center.³⁹

³⁹ Using the Weighted Mean was decided upon consultation with Con Edison staff.

Figure 7: Sample Data Distribution – Primary Feeders

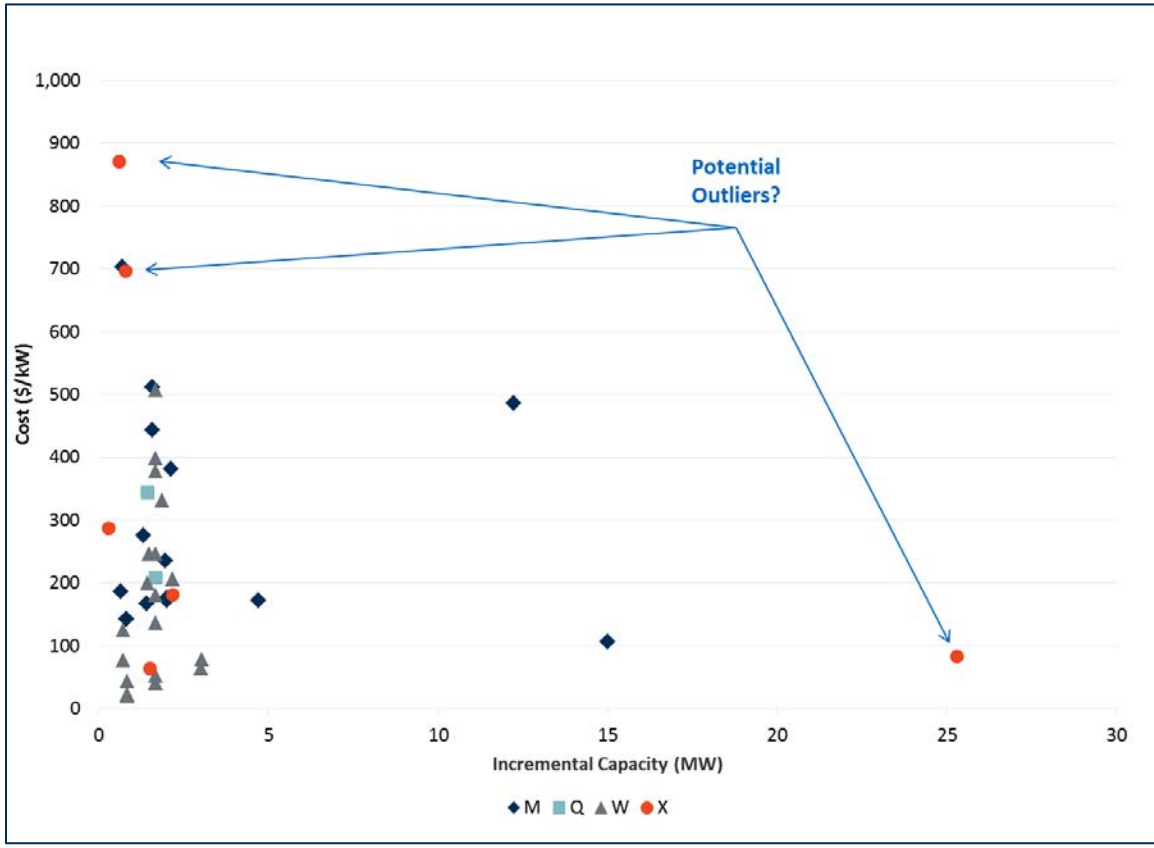

Table 8: Mean, Median, and Weighted Mean Values of Sample Data

Cost Center	Metric	M	X	B	Q	W	R
Primary Feeders	Median	186.00	233.81	N/A	276.07	135.95	N/A
	Mean	286.61	363.55	N/A	276.07	175.94	N/A
	Weighted Mean	271.13	121.51	N/A	270.53	184.42	N/A
Secondary Cables	Median	303.50	306.45	305.99	245.39	N/A	N/A
	Mean	431.49	439.30	324.08	254.24	N/A	N/A
	Weighted Mean	341.25	342.60	285.38	250.20	N/A	N/A
Distribution Transformers	Median	538.91	324.29	390.15	368.78	232.00	N/A
	Mean	531.21	374.26	397.76	593.34	295.71	N/A
	Weighted Mean	538.27	368.68	352.67	468.31	241.50	N/A

Table 9: Cost Estimates by Borough Group summarizes the cost estimates derived from the steps discussed above for the three lower voltage cost centers, by boroughs. Note that the cost estimates for boroughs within a borough group, such as Manhattan (M) and Bronx (X), or Brooklyn (B) and Queens (Q), are uniform. Staten Island (R) data is not available and upon discussion with Con Edison staff it is assumed to be similar to Westchester (W). Both Staten

Island (R) and Westchester (W) systems are predominantly overhead radial systems and both boroughs show similar levels of urbanization. Finally, no data for Secondary Cables is available for both Westchester (W) and Staten Island (R). The only Secondary Cable investment observed in the past four years within these two boroughs is one Load Relief project and four New Business project from a single year (2016), all in Westchester (W). The single Load Relief project had virtually zero cost. New Business projects are atypical and while the cost data can be relevant, the frequency of investments should not be assumed to repeat in the future. Upon discussion with Con Edison staff and observing the low load growth rate on the Load Areas within these boroughs, the Study assumes no Secondary Cable upgrades for both Westchester (W) and Staten Island (R).

Table 9: Cost Estimates by Borough Group

Cost Center	Borough Grouping Costs (\$/kW)			
	M/X	B/Q	W	R
Primary Feeders	213.41	270.53	184.42	184.42
Secondary Cables	341.56	276.51	N/A	N/A
Distribution Transformers	444.95	385.41	241.50	241.50

Note: Borough grouping costs are calculated by taking the incremental capacity-weighted average of historical total cost per incremental capacity.

Investment Timing and Location Estimates for the Lower Voltage Cost Centers

Once the investment costs are estimated, the second step is to identify the timing and location (when and where) of the investments. The approach to identify when and where varies by cost center.

For the Primary Feeder Cost Center, the Study looks at the individual feeders and estimates when the feeder loading level will reach the feeder capacity (design limit). Once the feeder loading reaches its capacity, an upgrade is needed. Future feeder loading is estimated by looking at the 2016 feeder loading data and applying a feeder loading growth rate going forward. The year to year feeder loading growth is assumed to coincide with the year to year load growth of the Load Area (forecasted in the LRP) where the feeder is located.⁴⁰ Table 10: Load Area Primary

⁴⁰ Con Edison has provided radial feeder forecasts for several area stations and switching stations. The Study relies on this forecast for any feeders in the Load Areas corresponding to the stations. The stations and corresponding Load Areas with radial feeders are: Plymouth St (Borough Hall/01B Load Area), Greenwood (Park Slope/02B Load Area), Bensonhurst No. 1 (Ocean Parkway/07B Load Area), Brownsville 2 (Richmond Hill/09B Load Area), Glendale (Maspeth/06Q Load Area), Corona No. 1 (Flushing/07Q Load Area), Dunwoodie North (Cedar St/20W Load Area), and Parkchester No. 2 (Northeast Bronx/05X Load Area).

Feeder Loading and Upgrade Needs, 2018-2027 summarizes the upgrade needs assessed.⁴¹ The Study assumes that reducing the load on any networked feeder will reduce the load on other networked feeders within the same Load Area; it also assumes that reducing the load on any radial (non-networked) feeder will have no effect on other feeders. Therefore, the MC calculations differ by these two distinct feeder types (networked vs radial).⁴²

Table 10: Load Area Primary Feeder Loading and Upgrade Needs, 2018-2027

Borough	Cost of One Upgrade \$/kW	Feeder Overloading		Upgrade Needs	
		Networked Feeders Count	Non-Networked Feeders Count	Load Areas Requiring Upgrades Count	Year of First Upgrade
M	213.41	55	0	13	2018
X	213.41	25	0	4	2018
B	270.53	40	0	8	2018
Q	270.53	20	0	3	2018
W	184.42	0	17	6	2018
R	184.42	0	1	1	2018

Future upgrades for the Transformer and Secondary Cable Cost Centers are assessed by reviewing historical occurrence—i.e., how frequent were upgrades needed historically, and how much load growth led to such frequencies—and applying the observations to the forecast future load growth. To assess the frequency of historical upgrades, a load growth threshold (“MW-threshold”) that measures how much load growth projection on average has triggered a new investment is introduced. For example, if there was an upgrade in 2015, what was the load growth projection (in MW) a year in advance (2014, in this example) when the upgrade need was studied and identified?⁴³ The MW-threshold is calculated by borough grouping and observes all available

⁴¹ This is the normal practice for Con Edison distribution engineering. Given that peak load conditions only prevail for a handful of hours, even when a feeder is “overloaded” (i.e., loading exceeds the capacity), there are short term remedies that can be applied to operations. However, these remedies are not long term solutions and the existence of such remedies does not negate the need for investments.

⁴² For example, assume a system that has two upgrade needs identified—one with a low cost and the other with a high cost. If the system is networked, the MC will equal the low cost option because one upgrade can alleviate the other. However, on a radial system the MC will equal the average of the two because one cannot alleviate the other. Note that this is an assumption. Con Edison has observed through studies that network load reduction may not equally reduce load on all feeders in the network. Future studies may consider this effect.

⁴³ While these studies are typically performed one to one and a half years ahead of time, the Study assumes they are performed only a year in advance.

historical samples within each borough group. Future upgrades are assumed to occur whenever the cumulative projected load growth at a Load Area over the ten-year Study period exceeds the MW-threshold.⁴⁴ Given that these two lower voltage cost centers are part of the radial system in many systems, the Study assumes that delaying a single investment does not delay subsequent investments elsewhere in the system. Table 11: Load Area Transformer and Secondary Cable Upgrade Need Estimates below summarizes the estimated investment frequencies and costs by borough for these two lower voltage cost centers.⁴⁵

Table 11: Load Area Transformer and Secondary Cable Upgrade Need Estimates

Borough	Distribution Transformers			Secondary Cables		
	MW-Threshold for One Upgrade	Cost of One Upgrade	Projected Upgrades, 2018-2027	MW-Threshold for One Upgrade	Cost of One Upgrade	Projected Upgrades, 2018-2027
	<i>MW</i>	<i>\$/kW</i>	<i>Count</i>	<i>MW</i>	<i>\$/kW</i>	<i>Count</i>
M	52.46	444.95	2	8.52	341.56	31
X	52.46	444.95	0	8.52	341.56	2
B	11.88	385.41	9	14.76	276.51	6
Q	11.88	385.41	9	14.76	276.51	8
W	0.22	241.50	86	N/A	N/A	0
R	0.22	241.50	25	N/A	N/A	0

C. FINANCIAL ASSUMPTIONS

The investment cost (in \$/kW) calculated using the incremental investment costs (net of salvage value) as the numerator and incremental capacity (net of existing asset capacity) as the denominator, is then annualized. The parameters (“Loaders”) used for the annualizing calculation are derived from various data sources provided by Con Edison and are summarized in Table 12: Parameters used for Annualizing Investment Costs below. Appendix-C: Loaders compares these values to those used in previous MCCOS.

⁴⁴ For example, if the MW-threshold indicates that, on average, an upgrade was planned for every 11 MW of load growth being forecasted, and the load forecast for the next ten years is expected at 7 MW a year (constant for all years), upgrades will occur in year 2 (when the cumulative load growth is 14 MW, exceeding the 11 MW-threshold), year 4 (when the cumulative load growth is 28 MW, exceeding the 11 MW-threshold for the second time), year 5 (when the cumulative load growth is 35 MW, exceeding the 11 MW-threshold for the third time), year 7 (when the cumulative load growth is 49 MW, exceeding the 11 MW-threshold for the fourth time), year 8 (when the cumulative load growth is 56 MW, exceeding the 11 MW-threshold for the fifth time), and year 10 (when the cumulative load growth is 70 MW, exceeding the 11 MW-threshold for the sixth time).

⁴⁵ For this exercise, observations from Westchester are assumed for both Westchester and Staten Island due to insufficient Staten Island data.

Table 12: Parameters used for Annualizing Investment Costs

Loader	Cost Center				
	Load Area				
	High Voltage System	Substation and Sub-transmission	Primary Feeder	Secondary Cable	Distribution Transformer
Varies Across Cost Centers					
Plant A&G Costs	0.07%	0.07%	0.00%	0.00%	0.07%
Cost Center O&M	2.92%	3.05%	2.37%	2.73%	2.73%
Common Across Cost Centers					
Inflation Rate	3.00%				
Common Plant %	7.59%				
Economic Carrying Charge	9.67%				
Working Cap as % of Electric PIS	2.65%				
Income Tax Rate	6.19%				
Regulated WACC	9.59%				
Non-Plant A&G	3.66%				
Revenue Requirement for Working Capital	15.78%				

The first half of this table shows the following two Loaders that vary across cost centers:

- Plant A&G Costs are calculated by dividing total plant A&G cost in a historical year by total insurable values in the same year, which results in 0.07% Plant A&G. Plant A&G is set to 0% for Primary Feeders and Secondary Cables.
- Cost Center O&M values are unique to each cost center and are based on 2013 Electric Embedded Cost Study Workpapers.⁴⁶ These values have not been updated since then because more recent studies have not been performed.

The second half of this table shows Loaders that are common across all cost centers:

- Inflation Rate is the commonly used value among other Con Edison filings.
- Common Plant % is calculated by dividing the common plant value by the electric plant value. These values are pulled from the 2015 and 2016 Annual Reports filed with the PSC, respectively.⁴⁷

⁴⁶ The Study assumes that equipment upgrades would typically require replacing it with the same kind (i.e., a transformer will be replaced with a larger transformer, not a conduit or other equipment) and that technical change for transformers and the other elements of the distribution system going forward is expected to be minimal. Therefore, the Study assumes the per-unit O&M costs assigned to transformers and the other elements of the distribution system will not differ significantly in the future and utilizes the values indicated in the Embedded Cost Study.

⁴⁷ Consolidated Edison Company of New York, Inc., 2015 and 2016 Electric and Gas Utilities Annual Reports, filed to the State of New York Public Service Commission.

- Economic Carrying Charge is calculated using the following formula:

$$\frac{(r - i) \times (1 + r)^n}{(1 + r)^n - (1 + i)^n} \times \text{Cost of Capital}$$

where

r = Discount Rate = 9.52%
 i = inflation rate = 3.16%
 n = Service life (years) = 51
 Cost of Capital = 1.4504

- Working Capital as % of Electric Plant in Service (PIS) is calculated by dividing working capital by total electric plant in service. Working capital is a 2016 estimate, and the total electric plant in service is from the aforementioned 2016 Annual Report.
- Income Tax Rate is calculated by applying weighted costs of debt, of customer deposits, and of common equity to the tax rate. The tax rate is updated for 2016; the weighted costs are from the 2016 CECONY Rate Case Capital Structure.⁴⁸
- Regulated WACC is calculated by summing up pre-tax weighted costs of debt, of customer deposits, and of common equity. All values are from the 2016 CECONY Rate Case Capital Structure.
- Non-Plant A&G is calculated by dividing social security and unemployment taxes by O&M less fuel, purchased power and transmission by others. Both values are from the aforementioned 2016 Annual Report.
- Revenue Requirement for Working Capital is calculated by summing up the Regulated WACC (i.e., composite incremental cost of capital) and the income tax component, both of which are described above.

D. CALCULATED MARGINAL COSTS

Table 13: 2018 Average MC by Borough and Cost Center (\$/kW) shows the average 2018 MCs by borough by cost center calculated through the approach discussed throughout this section.⁴⁹ As this table shows, the share of the three lower voltage cost centers (Primary Feeders, Transformers, and Secondary Cables) is larger than the share of the two higher voltage cost centers (High Voltage System and Load Area Substation and Sub-transmission).

⁴⁸ Consolidated Edison Company of New York, Inc., Electric Case 16-E-0060, Average Capital Structure & Cost of Money for 2017, 2018, and 2019.

⁴⁹ Average values shown in this table are simple averages, and not weighted.

Table 13: 2018 Average MC by Borough and Cost Center (\$/kW)

Borough	Cost Center					Total
	High Voltage System	Load Area Substation and Sub-Transmission	Primary Feeder	Distribution Transformer	Secondary Cable	
M	0.00	0.94	20.21	3.08	35.72	59.95
X	0.00	0.00	49.42	0.00	10.13	59.55
B	0.00	9.02	63.60	38.46	19.12	130.20
Q	73.62	32.94	48.97	53.62	34.56	243.71
W	0.00	0.00	19.08	167.21	0.00	186.29
R	0.00	0.00	7.48	123.33	0.00	130.81
System Average	10.94	7.03	34.54	45.47	23.58	121.56

Note: Average MCs are weighted on forecasted 2018 peak load and are rounded to the nearest cent.

Tables 13a through 13f below show the 2018 MCs for all 84 Load Areas by boroughs. Appendix-B: MC Calculation Example (Borough Hall Load Area) details the step by step calculation for all five cost centers using the Borough Hall Load Area (01B) located within Bronx as an illustrative example.

Table 13a: 2018 Manhattan Marginal Costs by Load Area and Cost Center (\$/kW)

Load Area	Code	Cost Center					Total
		High Voltage System	Load Area Substation and Sub-transmission	Primary Feeders	Secondary Cables	Distribution Transformers	
Washington Heights	01M	0.00	0.00	0.00	0.00	0.00	0.00
Harlem	02M	0.00	0.00	28.42	42.66	0.00	71.08
Yorkville	03M	0.00	0.00	58.48	26.99	0.00	85.47
Grand Central	04M	0.00	0.00	0.00	61.40	0.00	61.40
Times Square	05M	0.00	0.00	0.00	0.00	0.00	0.00
Madison Square	06M	0.00	0.00	0.00	35.52	0.00	35.52
Cooper Square	07M	0.00	0.00	16.40	63.17	0.00	79.57
City Hall	08M	0.00	0.00	0.00	67.29	0.00	67.29
Hunter	09M	0.00	0.00	0.00	0.00	0.00	0.00
Sheridan Sq.	10M	0.00	0.00	80.47	22.47	0.00	102.94
Plaza	11M	0.00	31.96	0.00	32.41	0.00	64.38
Empire	12M	0.00	0.00	0.00	0.00	0.00	0.00
Chelsea	13M	0.00	0.00	25.93	42.66	0.00	68.59
Randall's Island	14M	0.00	0.00	0.00	0.00	0.00	0.00
Cortlandt	15M	0.00	0.00	0.00	38.93	0.00	38.93
Pennsylvania	16M	0.00	0.00	113.25	243.38	77.83	434.46
Central Park	17M	0.00	0.00	17.98	0.00	0.00	17.98
Battery Park City	18M	0.00	0.00	0.00	0.00	0.00	0.00
Rockefeller Center	19M	0.00	0.00	0.00	0.00	0.00	0.00
Sutton	20M	0.00	0.00	0.00	67.29	0.00	67.29
Columbus Circle	21M	0.00	0.00	12.46	0.00	0.00	12.46
Canal	22M	0.00	0.00	0.00	22.47	0.00	22.47
Lincoln Square	23M	0.00	0.00	0.00	26.99	0.00	26.99
Lenox Hill	24M	0.00	0.00	69.50	42.66	0.00	112.17
Turtle Bay	25M	0.00	0.00	0.00	65.13	0.00	65.13
Greeley Square	26M	0.00	0.00	0.00	0.00	0.00	0.00
Fulton	27M	0.00	0.00	0.00	32.41	0.00	32.41
Herald Square	28M	0.00	0.00	0.00	0.00	0.00	0.00
Beekman	29M	0.00	0.00	0.00	0.00	0.00	0.00
Fashion	30M	0.00	0.00	0.00	0.00	0.00	0.00
Roosevelt	31M	0.00	0.00	28.42	42.66	0.00	71.08
Greenwich	32M	0.00	0.00	0.00	0.00	0.00	0.00
Park Place	34M	0.00	0.00	0.00	0.00	0.00	0.00
Hudson	39M	0.00	0.00	54.35	0.00	0.00	54.35
Bowling Green	40M	0.00	0.00	0.00	0.00	0.00	0.00
Freedom	41M	0.00	0.00	0.00	0.00	0.00	0.00
Kips Bay	43M	0.00	0.00	17.98	42.66	0.00	60.64
Triboro	44M	0.00	0.00	0.00	22.47	0.00	22.47
Midtown West	53M	0.00	0.00	28.42	0.00	0.00	28.42

Table 13b: Bronx 2018 Marginal Cost by Load Area and Cost Center (\$/kW)

Load Area	Code	Cost Center					Total
		High Voltage System	Load Area Substation and Sub-transmission	Primary Feeders	Secondary Cables	Distribution Transformers	
Riverdale	01X	0.00	0.00	0.00	0.00	0.00	0.00
West Bronx	02X	0.00	0.00	129.08	22.47	0.00	151.55
Fordham	03X	0.00	0.00	28.63	0.00	0.00	28.63
Central Bronx	04X	0.00	0.00	31.63	0.00	0.00	31.63
Northeast Bronx	05X	0.00	0.00	0.00	0.00	0.00	0.00
Southeast Bronx	07X	0.00	0.00	54.35	26.99	0.00	81.33

Table 13c: Brooklyn 2018 Marginal Cost by Load Area and Cost Center (\$/kW)

Load Area	Code	Cost Center					Total
		High Voltage System	Load Area Substation and Sub-transmission	Primary Feeders	Secondary Cables	Distribution Transformers	
Borough Hall	01B	0.00	43.45	121.67	69.36	141.72	376.19
Park Slope	02B	0.00	0.00	0.00	0.00	0.00	0.00
Crown Heights	03B	0.00	0.00	32.87	0.00	0.00	32.87
Flatbush	04B	0.00	0.00	36.59	0.00	0.00	36.59
Ridgewood	05B	0.00	0.00	104.16	28.76	72.09	205.01
Williamsburg	06B	0.00	25.32	116.19	52.73	81.94	276.18
Ocean Parkway	07B	0.00	0.00	0.00	0.00	0.00	0.00
Bay Ridge	08B	0.00	0.00	24.97	0.00	25.49	50.46
Richmond Hill	09B	0.00	0.00	132.85	16.60	25.49	174.94
Sheepshead Bay	10B	0.00	0.00	17.31	0.00	0.00	17.31
Brighton Beach	11B	0.00	0.00	0.00	0.00	0.00	0.00
Prospect Park	12B	0.00	25.32	0.00	0.00	0.00	25.32

Table 13d: Queens 2018 Marginal Cost by Load Area and Cost Center (\$/kW)

Load Area	Code	Cost Center					Total
		High Voltage System	Load Area Substation and Sub-transmission	Primary Feeders	Secondary Cables	Distribution Transformers	
Long Island City	01Q	96.58	0.00	93.38	132.66	185.87	508.49
Borden	02Q	0.00	107.71	68.89	34.54	48.39	259.52
Rego Park	03Q	96.58	0.00	0.00	0.00	0.00	96.58
Jamaica	05Q	96.58	0.00	0.00	19.94	30.61	147.13
Maspeth	06Q	0.00	164.09	0.00	0.00	0.00	164.09
Flushing	07Q	96.58	0.00	170.19	60.78	108.42	435.97
Jackson Heights	09Q	96.58	0.00	0.00	0.00	0.00	96.58
Sunnyside	10Q	0.00	107.71	0.00	0.00	0.00	107.71

Table 13e: Westchester 2018 Marginal Cost by Load Area and Cost Center (\$/kW)

Load Area	Code	Cost Center					Total
		High Voltage System	Load Area Substation and Sub-transmission	Primary Feeders	Secondary Cables	Distribution Transformers	
Washington Street	01W/09W	0.00	0.00	67.41	202.52	0.00	269.92
Rockview	02W	0.00	0.00	11.80	202.52	0.00	214.32
Ossining West	06W	0.00	0.00	37.49	202.52	0.00	240.01
Millwood West	07W	0.00	0.00	0.00	67.23	0.00	67.23
White Plains	08W	0.00	0.00	12.93	227.76	0.00	240.70
Granite Hill	10W/15W	0.00	0.00	38.11	227.76	0.00	265.87
Pleasantville	11W	0.00	0.00	0.00	66.71	0.00	66.71
Elmsford No. 2	12W	0.00	0.00	22.41	204.73	0.00	227.13
Buchanan	13W	0.00	0.00	0.00	174.85	0.00	174.85
Harrison	17W	0.00	0.00	0.00	67.23	0.00	67.23
Grasslands	19W	0.00	0.00	0.00	132.44	0.00	132.44
Cedar St	20W	0.00	0.00	0.00	111.29	0.00	111.29

Table 13f: Staten Island 2018 Marginal Cost by Load Area and Cost Center (\$/kW)

Load Area	Code	Cost Center					Total
		High Voltage System	Load Area Substation and Sub-transmission	Primary Feeders	Secondary Cables	Distribution Transformers	
Fresh Kills	01R	0.00	0.00	0.00	0.00	91.22	91.22
Fox Hills	02R	0.00	0.00	24.56	0.00	202.52	227.07
Wainwright	03R	0.00	0.00	0.00	0.00	48.05	48.05
Willowbrook	04R	0.00	0.00	0.00	0.00	67.23	67.23
Woodrow	05R	0.00	0.00	0.00	0.00	130.79	130.79

Table 14: Ten Year Average Total MC by Borough (\$/kW) shows the average total MCs by borough for 2018-2027.⁵⁰ The Study assumes the MC to drop to zero once an investment is made. Furthermore the Study does not make any estimates of investment needs beyond the ten year period. Therefore, as seen in Table 14: Ten Year Average Total MC by Borough (\$/kW), the MCs will naturally decline over years (because there is less that can be saved by avoiding incremental load growth).

⁵⁰ Average values shown in this table are simple averages, and not weighted.

Table 14: Ten Year Average Total MC by Borough (\$/kW)

Borough	2018	2019	2020	2021	2022	2023	2024	2025	2026	2027
M	59.94	56.41	40.98	35.94	33.15	31.24	31.92	26.83	22.27	8.61
X	59.55	52.58	44.92	42.88	47.01	45.15	44.36	31.61	20.93	0.00
B	130.20	107.63	78.66	64.92	52.02	50.19	42.98	38.08	37.03	15.97
Q	243.71	166.15	110.03	87.63	65.16	42.87	45.87	32.48	13.58	11.69
W	186.29	172.23	156.75	144.95	142.98	134.57	118.11	97.16	67.57	32.70
R	130.81	107.92	90.86	78.06	85.71	82.76	79.54	65.63	45.82	23.98
System Average	121.56	100.61	76.96	66.53	59.92	54.01	50.95	41.50	30.92	13.81

Note: Average MCs are weighted on forecasted peak load and are rounded to the nearest cent.

Tables 14a through 14f show the ten year MCs for all 84 Load Areas by boroughs.

Table 14a: Manhattan Ten Year Total MC by Load Area (\$/kW)

Load Area	Code	Total Marginal Cost									
		2018	2019	2020	2021	2022	2023	2024	2025	2026	2027
Washington Heights	01M	0.00	0.00	0.00	0.00	0.00	0.00	0.00	0.00	0.00	0.00
Harlem	02M	71.08	46.75	0.00	0.00	0.00	0.00	0.00	0.00	0.00	0.00
Yorkville	03M	85.47	62.52	68.52	75.09	82.29	90.18	98.83	25.93	28.42	0.00
Grand Central	04M	61.40	67.29	73.74	29.58	32.41	35.52	38.93	42.66	46.75	0.00
Times Square	05M	0.00	0.00	0.00	0.00	0.00	0.00	0.00	0.00	0.00	0.00
Madison Square	06M	35.52	38.93	42.66	46.75	0.00	0.00	0.00	0.00	0.00	0.00
Cooper Square	07M	79.57	87.20	44.33	48.58	53.24	58.34	63.94	38.93	42.66	46.75
City Hall	08M	67.29	73.74	29.58	32.41	35.52	38.93	42.66	46.75	0.00	0.00
Hunter	09M	0.00	0.00	0.00	0.00	0.00	0.00	0.00	0.00	0.00	0.00
Sheridan Sq.	10M	102.94	81.67	58.36	63.96	70.09	76.81	84.18	92.25	101.10	28.42
Plaza	11M	64.38	67.49	70.89	74.63	78.72	31.96	25.17	6.00	0.00	0.00
Empire	12M	0.00	0.00	0.00	0.00	0.00	0.00	0.00	0.00	0.00	0.00
Chelsea	13M	68.59	75.17	0.00	0.00	0.00	0.00	0.00	0.00	0.00	0.00
Randall's Island	14M	0.00	0.00	0.00	0.00	0.00	0.00	0.00	0.00	0.00	0.00
Cortlandt	15M	38.93	42.66	46.75	0.00	0.00	0.00	0.00	0.00	0.00	0.00
Pennsylvania	16M	434.46	393.75	349.13	233.14	173.12	138.49	151.77	166.32	131.04	61.23
Central Park	17M	17.98	19.70	21.59	23.66	25.93	28.42	0.00	0.00	0.00	0.00
Battery Park City	18M	0.00	0.00	0.00	0.00	0.00	0.00	0.00	0.00	0.00	0.00
Rockefeller Center	19M	0.00	0.00	0.00	0.00	0.00	0.00	0.00	0.00	0.00	0.00
Sutton	20M	67.29	73.74	29.58	32.41	35.52	38.93	42.66	46.75	0.00	0.00
Columbus Circle	21M	12.46	13.66	14.97	16.40	17.98	19.70	21.59	23.66	25.93	28.42
Canal	22M	22.47	24.63	26.99	29.58	32.41	35.52	38.93	42.66	46.75	0.00
Lincoln Square	23M	26.99	29.58	32.41	35.52	38.93	42.66	46.75	0.00	0.00	0.00
Lenox Hill	24M	112.17	91.78	49.35	54.08	59.27	64.95	71.18	78.01	54.35	28.42
Turtle Bay	25M	65.13	71.38	26.99	29.58	32.41	35.52	38.93	42.66	46.75	0.00
Greeley Square	26M	0.00	0.00	0.00	0.00	0.00	0.00	0.00	0.00	0.00	0.00
Fulton	27M	32.41	35.52	38.93	42.66	46.75	0.00	0.00	0.00	0.00	0.00
Herald Square	28M	0.00	0.00	0.00	0.00	0.00	0.00	0.00	0.00	0.00	0.00
Beekman	29M	0.00	0.00	0.00	0.00	0.00	0.00	0.00	0.00	0.00	0.00
Fashion	30M	0.00	0.00	0.00	0.00	0.00	0.00	0.00	0.00	0.00	0.00
Roosevelt	31M	71.08	46.75	0.00	0.00	0.00	0.00	0.00	0.00	0.00	0.00
Greenwich	32M	0.00	0.00	0.00	0.00	0.00	0.00	0.00	0.00	0.00	0.00
Park Place	34M	0.00	0.00	0.00	0.00	0.00	0.00	0.00	0.00	0.00	0.00
Hudson	39M	54.35	28.42	0.00	0.00	0.00	0.00	0.00	0.00	0.00	0.00
Bowling Green	40M	0.00	0.00	0.00	0.00	0.00	0.00	0.00	0.00	0.00	0.00
Freedom	41M	0.00	0.00	0.00	0.00	0.00	0.00	0.00	0.00	0.00	0.00
Kips Bay	43M	60.64	66.45	21.59	23.66	25.93	28.42	0.00	0.00	0.00	0.00
Triboro	44M	22.47	24.63	26.99	29.58	32.41	35.52	38.93	42.66	46.75	0.00
Midtown West	53M	28.42	0.00	0.00	0.00	0.00	0.00	0.00	0.00	0.00	0.00

Table 14b: Bronx Ten Year Total MC by Load Area (\$/kW)

Load Area	Code	Total Marginal Cost									
		2018	2019	2020	2021	2022	2023	2024	2025	2026	2027
Riverdale	01X	0.00	0.00	0.00	0.00	0.00	0.00	0.00	0.00	0.00	0.00
West Bronx	02X	151.55	134.94	116.74	96.80	106.08	85.11	93.27	71.08	46.75	0.00
Fordham	03X	28.63	31.37	34.38	37.68	41.29	45.25	49.59	54.35	28.42	0.00
Central Bronx	04X	31.63	34.67	37.99	41.64	45.63	50.01	23.66	25.93	28.42	0.00
Northeast Bronx	05X	0.00	0.00	0.00	0.00	0.00	0.00	0.00	0.00	0.00	0.00
Southeast Bronx	07X	81.33	57.99	32.41	35.52	38.93	42.66	46.75	0.00	0.00	0.00

Table 14c: Brooklyn Ten Year Total MC by Load Area (\$/kW)

Load Area	Code	Total Marginal Cost									
		2018	2019	2020	2021	2022	2023	2024	2025	2026	2027
Borough Hall	01B	376.19	242.47	161.13	83.02	32.87	36.02	0.00	0.00	0.00	0.00
Park Slope	02B	0.00	0.00	0.00	0.00	0.00	0.00	0.00	0.00	0.00	0.00
Crown Heights	03B	32.87	36.02	0.00	0.00	0.00	0.00	0.00	0.00	0.00	0.00
Flatbush	04B	36.59	40.10	43.95	48.16	52.78	57.84	63.39	29.99	32.87	36.02
Ridgewood	05B	205.01	185.19	202.95	164.30	99.10	69.13	75.76	83.02	32.87	36.02
Williamsburg	06B	276.18	249.05	118.95	90.89	99.60	109.16	61.51	67.41	73.87	0.00
Ocean Parkway	07B	0.00	0.00	0.00	0.00	0.00	0.00	0.00	0.00	0.00	0.00
Bay Ridge	08B	50.46	55.30	60.61	66.42	72.79	40.29	44.16	48.39	53.03	0.00
Richmond Hill	09B	174.94	152.24	127.36	139.58	113.49	124.37	136.30	109.90	120.44	73.87
Sheepshead Bay	10B	17.31	18.97	20.79	22.79	24.97	27.37	29.99	32.87	36.02	0.00
Brighton Beach	11B	0.00	0.00	0.00	0.00	0.00	0.00	0.00	0.00	0.00	0.00
Prospect Park	12B	25.32	13.60	0.00	0.00	0.00	0.00	0.00	0.00	0.00	0.00

Table 14d: Queens Ten Year Total MC by Load Area (\$/kW)

Load Area	Code	Total Marginal Cost									
		2018	2019	2020	2021	2022	2023	2024	2025	2026	2027
Long Island City	01Q	508.49	331.09	242.70	126.90	0.00	0.00	0.00	0.00	0.00	0.00
Borden	02Q	259.52	234.61	107.71	107.71	107.71	107.71	107.71	74.16	36.11	10.56
Rego Park	03Q	96.58	18.75	0.00	0.00	0.00	0.00	0.00	0.00	0.00	0.00
Jamaica	05Q	147.13	74.15	60.71	66.53	72.91	79.91	87.57	37.85	0.00	0.00
Maspeth	06Q	164.09	108.68	58.13	15.31	0.00	0.00	0.00	0.00	0.00	0.00
Flushing	07Q	435.97	351.21	225.27	207.40	187.82	66.76	73.16	80.18	48.39	53.03
Jackson Heights	09Q	96.58	18.75	0.00	0.00	0.00	0.00	0.00	0.00	0.00	0.00
Sunnyside	10Q	107.71	107.71	107.71	107.71	107.71	107.71	107.71	74.16	36.11	10.56

Table 14e: Westchester Ten Year Total MC by Load Area (\$/kW)

Load Area	Code	Total Marginal Cost									
		2018	2019	2020	2021	2022	2023	2024	2025	2026	2027
Washington Street	01W/09W	269.92	232.48	191.45	146.48	160.53	139.51	116.47	91.22	63.55	33.23
Rockview	02W	214.32	198.45	181.07	162.02	177.55	158.16	136.92	113.63	88.11	33.23
Ossining West	06W	240.01	199.69	182.43	163.51	179.19	159.95	138.88	115.78	63.55	33.23
Millwood West	07W	67.23	73.68	80.75	88.49	96.98	106.28	116.47	91.22	63.55	33.23
White Plains	08W	240.70	227.36	212.75	196.74	179.19	159.95	138.88	115.78	63.55	33.23
Granite Hill	10W/15W	265.87	254.95	242.98	229.87	215.49	199.74	155.57	134.07	110.51	57.79
Pleasantville	11W	66.71	36.69	40.20	44.06	48.29	52.92	57.99	63.55	33.23	0.00
Elmsford No. 2	12W	227.13	212.50	169.55	149.39	127.30	139.51	116.47	91.22	63.55	33.23
Buchanan	13W	174.85	155.20	133.66	146.48	160.53	139.51	116.47	91.22	63.55	33.23
Harrison	17W	67.23	73.68	80.75	88.49	96.98	106.28	116.47	91.22	63.55	33.23
Grasslands	19W	132.44	108.73	82.74	54.25	23.04	25.25	27.67	30.32	33.23	0.00
Cedar St	20W	111.29	121.97	133.66	146.48	160.53	139.51	116.47	91.22	63.55	33.23

Table 14f: Staten Island Ten Year Total MC by Load Area (\$/kW)

Load Area	Code	Total Marginal Cost									
		2018	2019	2020	2021	2022	2023	2024	2025	2026	2027
Fresh Kills	01R	91.22	63.55	33.23	0.00	0.00	0.00	0.00	0.00	0.00	0.00
Fox Hills	02R	227.07	185.52	166.89	146.48	160.53	139.51	116.47	91.22	63.55	33.23
Wainwright	03R	48.05	52.66	57.71	63.24	69.31	75.95	83.24	91.22	63.55	33.23
Willowbrook	04R	67.23	73.68	80.75	88.49	96.98	106.28	116.47	91.22	63.55	33.23
Woodrow	05R	130.79	106.91	80.75	88.49	96.98	106.28	116.47	91.22	63.55	33.23

Table 15: System Weighted Average MC by Cost Center by Year (\$/kW) below summarizes marginal costs by cost center for the ten-year study period at the system level.

Table 15: System Weighted Average MC by Cost Center by Year (\$/kW)

Cost Center	2018	2019	2020	2021	2022	2023	2024	2025	2026	2027
High Voltage System	10.94	2.14	-	-	-	-	-	-	-	-
Area Substation	7.03	5.02	3.56	2.46	2.17	2.17	2.09	1.31	0.61	0.18
Primary Feeder	34.54	27.16	21.54	18.34	15.88	14.38	13.09	10.79	8.31	3.78
Distribution Transformer	45.47	42.50	35.70	31.65	29.82	27.46	24.81	19.90	15.16	8.02
Secondary Cable	23.58	23.79	16.16	14.08	12.05	10.00	10.96	9.50	6.84	1.83
Total	121.56	100.61	76.96	66.53	59.92	54.01	50.95	41.50	30.92	13.81

Note: Average MCs are weighted on forecasted peak load and are rounded to the nearest cent.

III. Grouping for the VDER Proceeding

The locationally granular MCs can be used for a variety of purposes. For the VDER proceeding locational MCs can aid Con Edison evaluate the impacts of DER on a locational basis, establish LSRV areas, and set their values. To help establish LSRV areas, the 84 Load Areas are aggregated into groups. Representative MCs for these Load Area groups can be used to set the LSRV. There are two key purposes for grouping, rather than setting each Load Area as a separate LSRV area and providing 84 distinct values. First is to simplify and ease the process of identifying Load Areas with higher MCs that may have comparative benefits from DERs. Grouping also reduces the noise caused by MC differences among the Load Areas, which is likely a result of the approximations used in the MC calculations. The preferred number of groupings, from the administrative and processing perspective, is less than ten.

A. GROUPING BY DRIVERS

Grouping the 84 Load Areas can be done in a myriad of ways and with so many variables there is no “correct” approach—it is rather an art than science. One approach may be to group the Load Areas solely based on the calculated MCs, another may be to group them by the underlying drivers of investment needs that lead to positive MCs. The MC calculation for this Study heavily relies on various assumptions and approximations introduced to augment data limitations. Relying on the calculated MCs may simply magnify the potential error ranges of these assumptions and approximations. Therefore the Study groups the Load Areas by the underlying drivers of MC. Grouping by the fundamental drivers will furthermore allow Con Edison to keep the same grouping approach in future studies (as a starting point, and change as needed). However, in the future when a more comprehensive collection of granular data is available and the needs for approximating the investment costs, timing, and perhaps even location through grouping or other approximation approaches taken in this Study are reduced, a grouping approach that relies on the calculated MCs may become more appropriate.

The Study groups the 84 Load Areas by focusing on three distinct drivers, particularly considering how the MC calculation results can be used for the VDER process.

1. Cost estimates
2. Investment needs and timing
3. DER needs

Both the cost estimates and investment timings for the two higher voltage cost centers (High Voltage System and Load Area Substation and Sub-transmission) are taken from the LRP. However, DERs tend to be installed at lower voltage distribution networks that correspond closer to the three lower voltage cost centers (Primary Feeders, Distribution Transformers, and Secondary Cables). Furthermore, the MC calculation performed indicates that the lower voltage cost centers share a larger portion of the total MC. Therefore the Study focuses on the various drivers for the lower voltage cost centers.

For lower voltage cost centers cost estimates, the Study uses historical project samples that are aggregated on a borough grouping basis. Therefore grouping by borough and/or borough grouping to represent costs reflects this Study approach.

For lower voltage cost centers investment timing, the Study relies on load growth forecasts of the Load Areas.⁵¹ Load Areas were grouped into two—those with high load growth or low load growth, distinguished by whether the cumulative load growth within a given Load Area anticipated for the ten year Study period is above or below 20 MW.⁵²

Finally, the MC calculation by itself does not distinguish DER needs for individual Load Areas or its components. To assess such potential distinction, a clustering analysis of the diurnal load profile of all Load Areas is performed. The clustering analysis—details of which are discussed in Appendix-E: Load Profile Clustering—indicates that the 84 Load Areas’ load profiles can be clustered into three representative load profiles, as shown in Figure 8: Load Profile Cluster Centers below.

Figure 8: Load Profile Cluster Centers

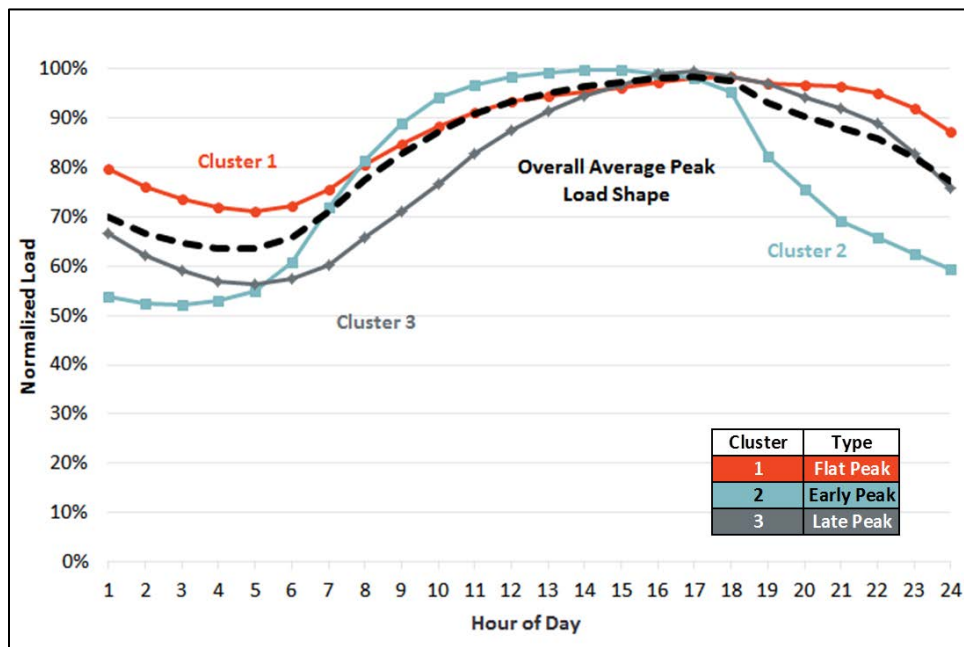

These clustered load profiles may be helpful in identifying the most apt DERs. For example, Load Areas that have Early Peak loads (Cluster 2 shown in the teal line) may benefit the most from PV

⁵¹ Both CAGR and the MW-Threshold can be considered to represent load growth. To be consistent with the Study approach, the MW-Threshold was selected for grouping.

⁵² Further details of grouping approaches are discussed in Appendix-D: Grouping Approaches.

systems because the peak is relatively flat during the hours when the sun is out, and the peak drops just around the time the sun starts to set. Comparing Flat Peak loads (Cluster 1 shown in the red line) and Late Peak loads (Cluster 3 shown in the grey line) to Early Peak loads (Cluster 2 shown in the teal line) may indicate that both the Flat Peak (Cluster 1 shown in the red line) and Late Peak (Cluster 3 shown in the grey line) load profiles may prefer a DER option that provides constant power throughout the day. Between the Flat Peak and Late Peak load, the Late Peak loads (Cluster 3 shown in the grey line) can take advantage of load shifting options more than Flat Peak loads (Cluster 1 shown in the red line) because of the larger spread between the maximum (i.e., peak) and minimum load. However, if the grouping is purely for responding to a rate case and not for DER related processes, this third driver may not be relevant.

B. GROUPING RESULTS

Based on these three drivers, the 84 Load Areas are initially grouped into the ten groups (“Initial Groups”), then further aggregated into six groups (“Aggregate Groups”) based on their similarity of the average MCs for 2018. Table 16: Groups below shows the ten Initial Groups, their characteristics and average 2018 MCs, and the resulting six Aggregate Groups and their average 2018 MCs (weighted by the Load Areas’ forecasted 2018 peak load).

Table 16: Groups

Initial Group					Aggregate Group		
Group #	Borough Groupings	Load Growth	Load Profile	Average 2018 MC (\$/kW)	Group #	Load Profile	Average 2018 MC (\$/kW)
IG 1	BQ	High	Flat	369	AG 1	Flat Peak	369
IG 2	BQ	Low	Early Peak	260	AG 2	Early Peak	256
IG 3	MX	High	Early Peak	255			
IG 4	W	All (Low)	*1	186	AG 3	Mostly Late Peak	171
IG 5	R	All (Low)	*2	131			
IG 6	BQ	Low	Flat	95	AG 4	Mostly Flat Peak	71
IG 7	MX	Low	Flat	56			
IG 8	BQ	Low	Late Peak	30	AG 5	Late Peak	27
IG 9	MX	Low	Late Peak	0			
IG 10	MX	Low	Early Peak	26	AG 6	Early Peak	26

*1: 14 Load Areas with 1 Early, 2 Flat, and 11 Late Peak profiles

*2: 5 Load Areas with 1 Flat and 4 Late Peak profiles

Figure 9: MC and Combined Load of the Groups visualizes the average (weighted by the forecasted 2018 peak load) 2018 MC and combined load (sum of the forecasted 2018 peak load) of the Load Areas for the ten Initial Groups and six Aggregate Groups. The blue boxes and red boxes represent the Initial Groups and Aggregate Groups respectively in the order shows in Table 15: Groups above. The black text indicates the Initial Groups (abbreviated as IG #) and red text/values are Aggregate Groups (abbreviated as AG #) and their corresponding average 2018 MCs (in \$/kW). The combined capacities of the Load Areas that are assigned to each Aggregated

Group (a sum of the estimated 2018 peak load of the corresponding Load Areas) are shown at the bottom of this figure.

Figure 9: MC and Combined Load of the Groups

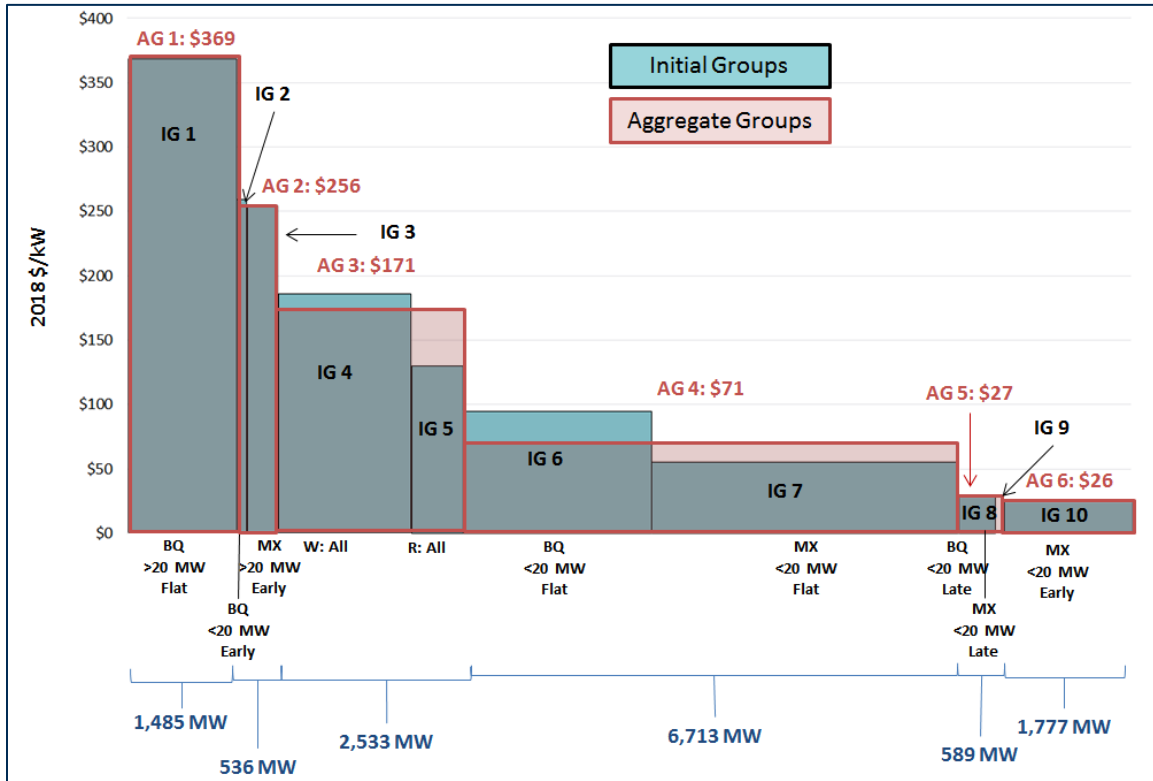
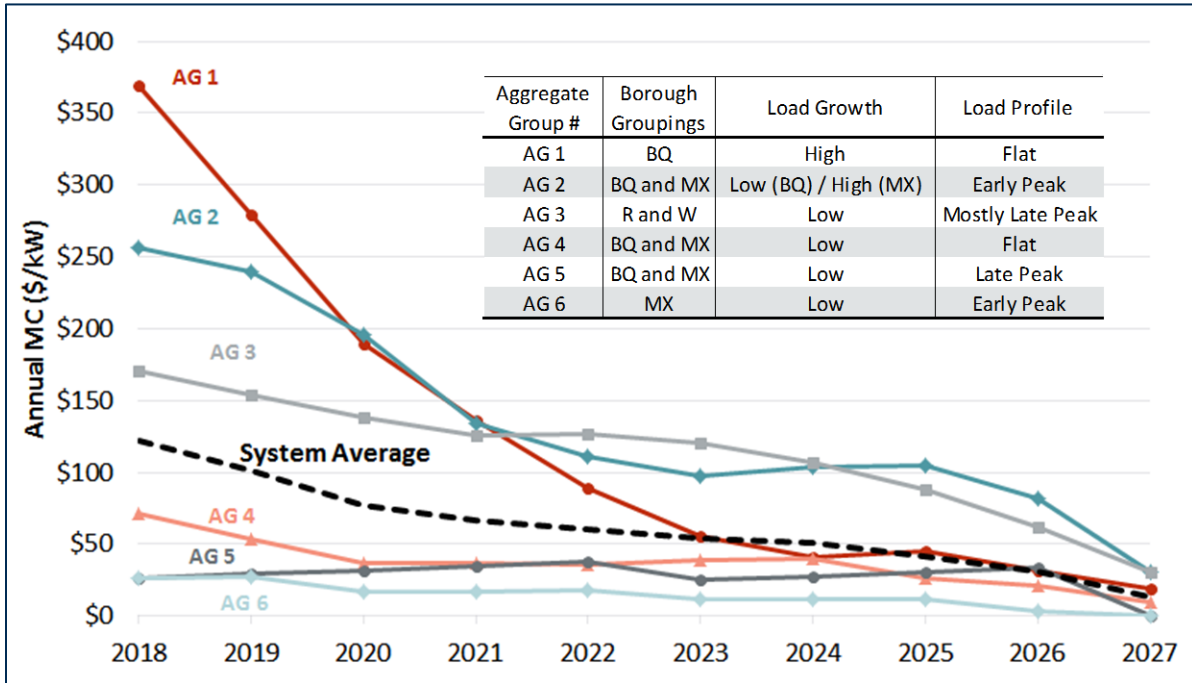

Figure 10: Ten Year Average MC for Aggregate Groups and System Average shows the MC for the six aggregate groups, along with the system average MC (weighted by the forecasted future years' peak loads), for the ten year Study period.

Figure 10: Ten Year Average MC for Aggregate Groups and System Average



This figure clearly distinguishes two Aggregate Groups (AG 1 shown in the red line and AG 2 shown in the teal line) to have MCs significantly above the system average in the early years and are likely to benefit more from peak load reductions, which DERs may be able to provide. In particular, higher MCs combined with the Early Peak load profile (suitable for PVs) for AG 2 suggests that the Load Areas in this Aggregate Group could benefit from PVs or other DERs with similar characteristics. These two Aggregate Groups include most high load growth (more than 20 MW over the ten year Study period) Load Areas. All other Aggregate Groups (AG 3 shown in the light grey line, AG 4 shown in the pink line, AG 5 shown in the navy line, and AG 6 shown in the light teal line) are groups with lower load growths (less than 20 MW over the ten year Study period). Among the low load growth Aggregate Groups, AG3 (shown in the light grey line) representing Load Areas with radial systems (Westchester and Staten Island) have higher MCs than the other Aggregate Groups. This can be partially driven by the Study assumption used for the radial systems—that unlike network systems, one upgrade in a radial system will not offset another, leading to a larger number of upgrades needed. These observations can be used to value the benefits of DERs, including their location, as part of the VDER process.

C. APPLYING THE GROUPING RESULTS

Using these MC observations as part of the VDER process requires caution and understanding of the underlying assumptions made through the MC calculations. Once installed, many DERs can be expected to last twenty years or more. The Study only covers a ten year period. Furthermore, a large portion of the underlying assumptions used for the MC calculation changes year by year—for example, the upgrade needs of the lower voltage cost centers are only identified a year

to a year and a half ahead—rendering that locational MCs may not always be the most appropriate option for assessing the 20 year payment to a new DER.

Even if relying on MCs is the best alternative available, there are cases where the MCs by themselves do not represent the potential benefits (i.e., avoided costs) that can be provided by DERs. For example, the MCs for AG 1 includes the Rainey-Corona Transmission Project—an investment in the High Voltage System with an MC of nearly \$100/kW in 2018 (as seen in seen in Table 13d: Queens 2018 Marginal Cost by Load Area and Cost Center (\$/kW) for the five relevant Load areas) and \$20/kW in 2019.⁵³ Investments to the Rainey-Corona Transmission Project have already been made and therefore are not avoidable as other future projects are. Another example may be MCs for AG 3 that represents Westchester and Staten Island. Systems in these two boroughs are largely radial where the Study assumes upgrades will only eliminate the needs for the specific location and not benefit other parts within the same system, as a networked system would—therefore, a single upgrade may not be sufficient to avoid the MC.⁵⁴

It should also be noted that the incremental load-serving capacity used for calculating the MCs is post-contingency capacity that may be further reduced based on system specific conditions. Therefore if these MC values are to be used as a guideline for evaluating the benefits of DERs, the capability of DERs should not be taken at face value—the level of reliability provided by these alternatives may not be comparable.⁵⁵ Another reliability concern may be the availability of the DERs. If DERs are awarded the avoided cost, will the DER held responsible at the same level as the utility would for not performing in real time? Or will the DER have options to walk away without paying any penalty other than forgoing the agreed upon payment? And in such cases,

⁵³ The relevant Load Areas are Long Island City (01Q), Rego Park (03Q), Jamaica (05Q), Flushing (07Q), and Jackson Heights (09Q), all showing a 2018 MC of \$96.58/kW. This value includes investments already made in 2016 and 2017.

⁵⁴ For example, assume a given radial Load Area requires two upgrades, one with a higher cost and the other with a lower cost. The MC will likely be a value in between these two costs (such as a weighted average value). Compensating a DER that relieves the need for the lower cost upgrade need will not avoid the MC entirely.

⁵⁵ A study performed by EPRI titled “Time and Locational Value of DER – Method and Applications” dated October 2016 (available at: <https://www.epri.com/#/pages/product/3002008410/>) reviews methods for valuing the temporal and spatial impacts of DER on both radial and network distribution systems of Con Edison and Southern California Edison. One of the findings for Con Edison’s network systems is: “Network systems are characterized by complex and multi-directional power flows, so the effect of DER located close (in geographic terms) to a violation may become dispersed. In some cases, dispersion is so significant that the DER may only deliver a fraction of its nameplate capacity toward mitigating a violation.” In addition, the study finds that: “For radial systems, DER located downstream from a capacity-constrained asset (relative to the substation) can contribute directly to relieving the violation. However, radial systems are often reconfigured in order to meet new load growth, perform maintenance, or for other operational considerations, to the point where the DER could have little or even an adverse impact.”

will the utility be asked to provide a back-stop solution? These differences should also be taken into account when assessing the value DERs may provide.

Finally, timeliness in action is important. As Figure 10: Ten Year Average MC for Aggregate Groups and System Average shows, the MCs of the six Aggregate Groups will converge after five years. This should demonstrate to DER developers the diminishing return (as observed in most investments) and also the first runner advantage. For policy makers, this MC change indicates the need for a speedy response should a policy (or incentive) to guide DER investments of the appropriate type to the best locations be needed. And these policies need to be adjusted periodically. The changing MC over time also illustrates the importance of refreshing the MCCOS every two to three years and modifying such policies and/or incentives in a timely manner to reflect the updated MCCOS results.

IV. Conclusion and Recommendations

The Study develops MCs for the 84 different Load Areas within the Con Edison service territory. The MCs were developed for five cost centers over a ten year period from 2018 through 2027. These 84 Load Areas are further aggregated into six groups that can be used as a proxy for LSRV areas. The grouping has shown two groups to have potentially higher LSRVs, particularly in the first five years—one group that approximately covers the Load Areas with high load growth located within the BQ borough grouping with Flat Peak load profiles, and the second group with Early Peak load profiles within the BQ and MX borough grouping—indicating these Load Areas could benefit more from peak load reduction, one of the benefits that potentially can be provided by DERs. The second group with the Early Peak load profile indicates a good opportunity for PVs or DERS with similar characteristics. At the same time the grouping has identified that all other boroughs with low load growth, in particular those with network systems, will have MCs that are near, or lower than, the system average MC and perhaps may not benefit as much from peak load reduction. Among the low load growth Load Areas, radial systems (Westchester and Staten Island) show higher MCs than other networked systems. This can be partially driven by the Study assumption used for the radial systems—that unlike network systems, one upgrade in a radial system will not offset another, leading to a larger number of upgrades needed.

Relying on MCs as one of the metrics to evaluate and determine LSRV requires caution. DERs, once installed, will likely be in service for 20 years or more. MCs, on the other hand, is studied over a shorter time period (ten years in this Study) and furthermore relies on assumptions that are made at a much shorter horizon—for example the upgrade needs for lower voltage cost centers are studied and identified only a year to a year and a half in advance. Even if relying on MCs is the best alternative, the MCs by themselves should not be translated directly as the LSRV. The estimated reliability contribution from DERs among other factors, including the underlying assumptions used in calculating MCs, need to be considered and adjusted for appropriately.

In addition, the rapid year by year change in MC should be noted. The MCs for the six groups identified in this Study converge after five years, indicating the need for a speedy response should a policy (or incentive) to guide DER investments of the appropriate type to the preferred location is desired. It also illustrates the importance of refreshing the MCCOS study periodically and modifying such policies and/or incentives in a timely manner to match the updated MCCOS results.

In updating future MCCOS, there are several recommendations for improvements. The MC calculation—in incremental cost (\$/kW)—largely depends on available information from actual or planned projects. The data were relatively limited for this Study because of its being the first of its kind. In addition, the relative newness of the enterprise resulted in the required data not having been systematically collected to support such a study. Improving both the data quality and quantity (availability) for the various projects used to estimate the costs and frequency of

upgrades in the future will lead to better MC calculations.⁵⁶ Data collected over multiple years may also be used to estimate future costs—such as by observing a trend in costs over the year—rather than assuming historical prices will carry forward. Second, the Study assumes upgrades on networked systems can benefit all other parts of the network. However, this assumption may not necessarily be true in all instances, and therefore, would warrant further investigation. Third, the Study assumes zero salvage value for any asset that is being replaced. An internal review of the salvage values could improve the Study results. Similar to the cost estimates, data collected over multiple years can also be used to estimate future salvage values. Should this review or data collection be difficult, an alternative approach in calculating the MCs may be to simply assess the benefits of delaying the investment by one year. And finally, Loaders that are sourced from the Embedded Cost Study should be updated once a new study becomes available.

⁵⁶ Increasing data samples may also be a challenge given the flat load growth being projected.

Glossary

Commission–The New York Public Service Commission

DER –Distributed Energy Resource

DPS –Department of Public Service

kVA –kilo-volt-amperes

kW -kilo-watts, equal to 1000 watts

LRP–Load Relief Program

LSRV –Locational System Relief Value

MC – Marginal Cost

NPV–Net Present Value

PV–Photovoltaic

REV–Reforming the Energy Vision

VDER –Value of Distributed Energy Resources

Appendix-A: Wires Options – EnerNex Report



Electric Utilities Traditional Wires Options to
Meet Load Growth

Project:

Marginal Cost of Service Study

Prepared for



Prepared by:

EnerNex
620 Mabry Hood Road, Suite 300
Knoxville, TN 37932

May 16, 2018

VERSION	DATE	NOTES
1	08/11/2017	Initial draft submitted to The Brattle Group, Inc.
2	09/07/2017	The entire report is revised and rearranged in order to classify the utilities traditional wires options into categories for sub-transmission, load area substation, and lower voltage distribution systems.
3	04/03/2018	The approximate marginal cost (MC) values of various wires options for capacity addition are added in the report.
4	04/12/2018	Nomenclature is revised throughout the text to make it consistent with the other manuscripts of this project.
5	05/16/2018	The entire report is revised in order to improve the text.

SUMMARY

Electric distribution utilities plan their transmission and distribution (T&D) infrastructure investments years ahead in order to build sufficient capacity to meet customer energy requirements reliably. This report briefly describes various common wires options adopted by distribution utilities to increase T&D capacity in order to accommodate load growth.

Table of Contents

Section	Page
1.0 ELECTRIC UTILITIES TRADITIONAL WIRES OPTIONS TO MEET LOAD GROWTH.....	4
1.1 SUB-TRANSMISSION.....	4
1.1.1 <i>Replace Feeder Sections</i>	5
1.1.2 <i>Add New Feeders</i>	5
1.1.3 <i>Improve Reactive Power Compensation</i>	5
1.1.4 <i>Implement Dynamic Feeder Rating (DFR) System</i>	6
1.2 LOAD AREA SUBSTATION	6
1.2.1 <i>Load Transfer</i>	7
1.2.2 <i>Upgrade Transformer Cooling</i>	8
1.2.1 <i>Replace Transformer</i>	8
1.2.2 <i>Add New Transformer</i>	9
1.2.3 <i>Add New Load Area Substation</i>	9
1.2.4 <i>Replace Switchgear</i>	9
1.2.5 <i>Uprate Substation Busbar Cooling</i>	9
1.2.6 <i>Replace Bus Sections</i>	11
1.2.7 <i>Improve Reactive Power Compensation</i>	11
1.3 LOWER VOLTAGE DISTRIBUTION SYSTEM	12
1.3.1 <i>Primary Feeders</i>	12
1.3.1.1 <i>Feeder Load Transfer</i>	12
1.3.1.2 <i>Operational Switching Planning</i>	13
1.3.1.3 <i>Replace Primary Feeder Sections</i>	13
1.3.1.4 <i>De-Bifurcate Feeders</i>	14
1.3.1.5 <i>Add New Primary Feeders</i>	15
1.3.1.6 <i>Improve Reactive Power Compensation</i>	15
1.3.1.7 <i>Implement Dynamic Feeder Rating (DFR) System</i>	15
1.3.2 <i>Distribution Transformers</i>	15
1.3.2.1 <i>Replace Distribution Transformer</i>	16
1.3.2.2 <i>Add New Distribution Transformer</i>	16
1.3.3 <i>Secondary Cable/Feeder</i>	16
1.3.3.1 <i>Replace Secondary Sections</i>	16
1.3.3.2 <i>Add New Secondary Sections</i>	16

1.0 ELECTRIC UTILITIES TRADITIONAL WIRES OPTIONS TO MEET LOAD GROWTH

Electric utilities develop 2, 5, 10, or 20 year infrastructure plans for their transmission and distribution (T&D) systems in order to maintain sufficient capacity to reliably meet customer load. These plans contain a variety of wires-based work practices that can be grouped into three categories based on three distinct segments of power delivery infrastructure; (1) sub-transmission, (2) load area substation, which both correspond to the Load Area Substation and Sub-transmission Cost Center discussed in the main report, and (3) lower voltage distribution. The lower voltage distribution segment is further divided into subcategories of (a) primary feeders, (b) distribution transformers, and (c) secondary cables/feeder, also corresponding to the three lower voltage cost centers, namely the Primary Feeder, Distribution Transformer, and Secondary Cable Cost Centers.

It should be noted that the selection of a particular wire option or project type from these practices depends on multiple factors that are system and location dependent. Moreover, cost and lead times are critical selection criteria.

This appendix summarizes these wires options and furnishes the approximate ranges of marginal cost (\$/kW) associated with these options. These costs are based on EnerNex prior distribution planning experience and the cost data provided by Con Edison. The MCs exhibit high variability from utility to utility and from project to project within a utility¹ and the sample size used to determine the ranges of marginal costs is relatively small. Therefore, the ranges given in this report do not cover all utilities and projects and should be used carefully. For examples, the ranges given here should not be used for comparing between alternatives for a single location.

1.1 SUB-TRANSMISSION

Sub-transmission systems connect a high voltage transmission system with load area substations via underground cables and overhead conductors operating between 69kV and 138kV. This section describes the various types of traditional project options to enhance the capacity of sub-transmission systems. The estimated range of MCs for sub-transmission projects are given in

¹ The following study shows that the marginal cost variation from utility to utility can be significantly high. W. Shirley, R. Cowart, R. Sedano, F. Weston, C. Harrington, D. Moskovitz, State Electricity Regulatory Policy and Distributed Resources: Distribution System Cost Methodologies for Distributed Generation, CO, Golden: NREL-National Renewable Energy Lab., 2001.

Table I. Observing the range, Con Edison’s estimated MCs appear to be at the high end of the range. In addition to the cost range, the table itemizes the percentage share range of individual cost categories such as material and equipment, labor, others, and contingency.

Table I: Approximate Marginal Cost (\$/kW) of Sub-transmission Wires Options

Cost	Replace Feeder Sections	New Feeders	Reactive Power Compensation
Marginal Cost (\$/kW)	110-350	110-1090	230-690
Materials & Equipment (%)	30-60	2-60	10-70
Labor (%)	25-50	10-30	20-85
Others (%)	10-25	10-90	5-15
Contingency (Add %)	10-60	10-40	10-100

1.1.1 *Replace Feeder Sections*

Feeder section replacement refers to installing a higher rating cable or conductor in place of an already existing one of a lower rating. These replacements are usually performed when a feeder section capacity is limiting the downstream power delivery capacity in the load area. For example, if a load area substation has the capacity to supply forecasted increased load but the incoming cable from a High-Voltage switching station has a lower capacity than the load area substation, a feeder section replacement to a higher rating would be required. Higher rating brings benefits of additional capacity, lower voltage drop, and lower losses. Larger cable or wire size always means higher fault current. This may lead to upgrades in the capacity of breakers, reclosers, and sectionalizers at the upstream transmission substation.

1.1.2 *Add New Feeders*

The addition of capacity at a load area substation may require a capacity increase at sub-transmission level by the addition of new feeder between transmission switching station and the area substation.

1.1.3 *Improve Reactive Power Compensation*

Reactive impedances of lines and load often result in a low power factor causing poor transmission and distribution system performance. Adequate reactive power (VAR) control can

be applied to achieve a power factor closer to unity, which helps to improve voltage profile, power transfer capacity/efficiency, and system stability. Capacitors and inductors are commonly used elements that serve as VAR sources or sinks, respectively. The VAR compensation can be performed by two ways based on the connection of VAR elements in the system:

- a) **Series compensation:** In this method, equivalent line impedance is modified by the addition of VAR elements in series with the line.
- b) **Shunt compensation:** This method modifies the equivalent impedance of the load by the addition of VAR elements in parallel with the load.

VAR compensators are also classified depending on the technology used in their implementation.

- a) **Mechanically switched capacitors:** Capacitor banks are switched into or out of the system depending on the total VAR requirement by the use of mechanical switches and relays.
- b) **Static VAR compensators (SVC):** In this technology, reactive power elements (reactors and capacitors) are actively controlled by electronic switches such as thyristors in order to provide the required VAR support.

1.1.4 *Implement Dynamic Feeder Rating (DFR) System*

Dynamic feeder rating (DFR) systems are an alternative to analytic methods for determining the real-time conductor operating temperature and corresponding real-time cable ratings. A DFR system consists of remote terminal units positioned along the cable route which communicates with a central computer hosting an application to calculate a dynamic thermal rating. The goal of a dynamic rating system is to maximize the cable system's available capacity in real time by utilizing critical thermal measurements without exceeding industry defined limits. The installation of a DFR system on a sub-transmission feeder increases the power transfer capability.

1.2 LOAD AREA SUBSTATION

Load area substations are used to transform power from transmission voltages (69kV, 138kV, and 345kV) to distribution voltages (13kV, 27kV, and 33kV). The main components of a load area substation include transformers, switchgears, and busbars. The estimated range of MCs for load area substation projects and cost breakout by cost categories are shown in Table II. Note that the marginal cost ranges in the table have some artifacts due to the aforementioned low

sample size – for instance, the upper range for the marginal cost of ‘New Load Area Substation’ is relatively low compared to the upper range of other options such as ‘Add Transformer’, which, intuitively, should be lower.

Table II: Approximate Marginal Cost (\$/kW) of Load Area Substation Wires Options

Cost	Load Transfer	Transformer Cooling Upgrade	Replace Transformer	Add Transformer	New Load Area Substation	Replace Bus Sections
Marginal Cost (\$/kW)	90-3250	70-330	110-6930	110-3130	150-2270	9-690
Materials & Equipment (%)	20-30	45	45-75	20-75	45	25
Labor (%)	40-60	45	15-35	15-45	45	40
Others (%)	10-40	10	10-25	10-40	10	35
Contingency (Add %)	10-50	45	10-50	10-50	10	45

1.2.1 *Load Transfer*

Load area substations usually serve a dedicated region. Similarly, feeders and distribution networks have distinct service areas. Cumulatively, the customers in a load area substation’s or feeder’s service territory determine its load, and their simultaneous peak demand defines the maximum power the substation must serve. It is possible to expand or shrink a substation or feeder’s service area significantly, increasing or decreasing its netload, or keeping its load constant over time as the demand in a region gradually grows. In a load transfer between load area substations, the load is picked up by the substation receiving the additional load, and thus increasing its service area.

Load transfer between substations can be performed in the following two ways; (1) a direct link between area substations or (2) through a link between feeders of two neighboring areas substation. Such transfer is contingent on the load area substation and the feeding sub-transmission feeders where the load is being transferred both having sufficient capacity to handle the additional load. Usually, load transfer between substations involves some portions of feeder addition and upgrades in order to construct an adequate capacity link between loads being transferred and receiving substation connections. Load transfers allow for a more granular adjustment of capacity and, therefore, can be a suitable option for keeping expansion cost down as it saves equipment upgrade cost – in particular considering the fact that equipment such as transformers are available only in large discrete sizes.

1.2.2 Upgrade Transformer Cooling

Electrical equipment's (e.g., transformers, bus bars, circuit breaker) ability to handle a particular load is constrained by the temperature rise it experiences due to electrical losses. The loading capability of equipment can be increased by adding an external cooling system to accelerate the dissipation rate of heat produced. For example, many manufacturers offer optional oil pumps that circulate the transformer oil for more even distribution of heat and radiators with fans to assist in removing heat, and thus keeping the transformer hottest-spot-temperature within acceptable limits.² For example, installing fans on an 83 MVA transformer can increase its load capacity by over 15%. Figure 1 depicts the cooling of a transformer using external fans.



Figure 1: Transformer cooling using external fans.

1.2.1 Replace Transformer

Transformer replacement refers to installing a new transformer of higher ratings in place of an existing transformer. While transformer replacements typically occur when they are near the end of their useful lives, situations may arise when replacements of the relatively new transformer are conducted to meet growing demand. These cases are usually observed when no other alternative is viable (load cannot be transferred to the neighboring substation, the substation does not have space for additional transformers, etc.).

² Some utilities spray water or put dry ice on transformers to temporarily lower their operating temperature.

1.2.2 *Add New Transformer*

A new transformer is added to a load area substation when the capacity of existing transformers cannot meet the demand and the substation has sufficient space to install additional transformers along with associated switchgear, buses, and feeders. Although an expensive measure, the addition of transformers is typically a cheaper alternative compared to building a new substation.

1.2.3 *Add New Load Area Substation*

This alternative requires (1) acquiring the site, (2) installation of new equipment, such as circuit breakers, relays, transformers, bus work, and high voltage lines. Installing a new substation is typically much more expensive than other alternatives and is normally considered when other options are not viable.

1.2.4 *Replace Switchgear*

Switchgears are devices that protect electrical equipment and circuit during abnormal (fault) conditions by interrupting the supply of electricity. The normal, emergency, and short circuit ratings of switchgear are required to be equal or higher than the supplied power in order to work reliably. Increased load and impedance changes due to upgrades to substation or feeders may lead to scenarios in which replacement of switchgear is warranted to avoid damage to the equipment and surroundings.

1.2.5 *Uprate Substation Busbar Cooling*

A substation busbar is a metallic conductor (strip or bar) or a group of conductors that are used to connect incoming and outgoing feeders with other equipment in the substation. Typically at load area substations, two bus groups are established; one for the high voltage and another for the low voltage side. There are several types of bus bar arrangements in combination with protective devices and the choice of particular arrangement depends on factors such as system voltage, the position of a substation in the system, reliability of supply³, the flexibility of supply restoration

³ To achieve higher reliability, busbars are arranged such that faulty section of the bus can be isolated and supply can be rerouted from other sections of the busbars.

and busbar extensions⁴, and cost. Figure 2 and Figure 3 show busbar sections in a typical substation's single line diagram and real installation, respectively.

As in any electrical equipment, the normal, emergency, and short circuit ratings of all bus sections in a substation are required to be equal or higher than the expected power flow through them. Increased load and other changes (e.g., configuration, and equipment upgrade at substation) may lead to scenarios in which power flow exceeds the ratings of a particular weaker bus section. In such scenarios, increased ratings of existing bus can be achieved with the addition of external forced cooling, which keeps the temperature of the busbar within acceptable limits.

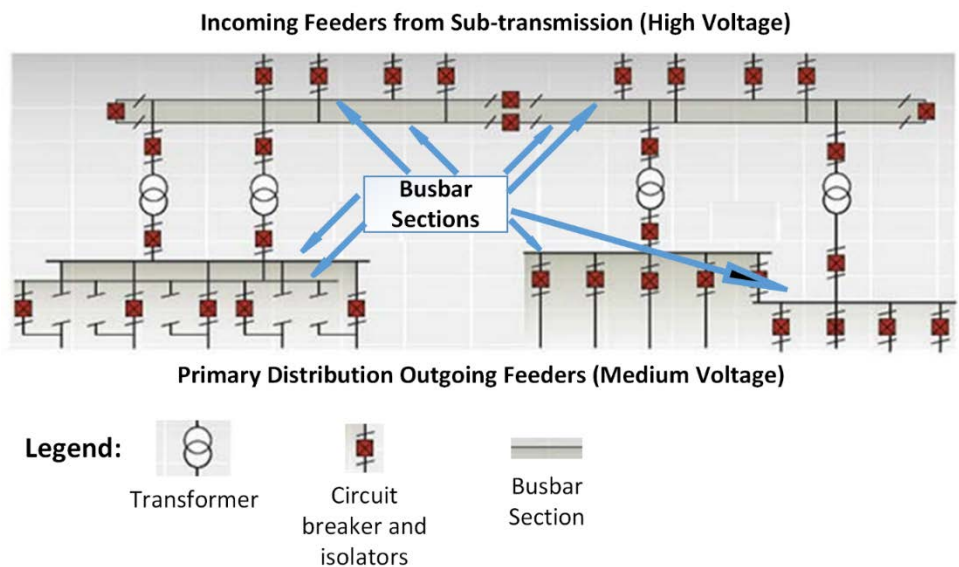

Source: https://www.pacw.org/no-cache/issue/december_2014_issue/cover_story/standards_based_engineering_of_pac_systems.html

Figure 2: A typical load area substation single line diagram showing its major components.

⁴ Restoration flexibility includes those for isolating the faulty parts of busbar and rerouting the power from other sections.

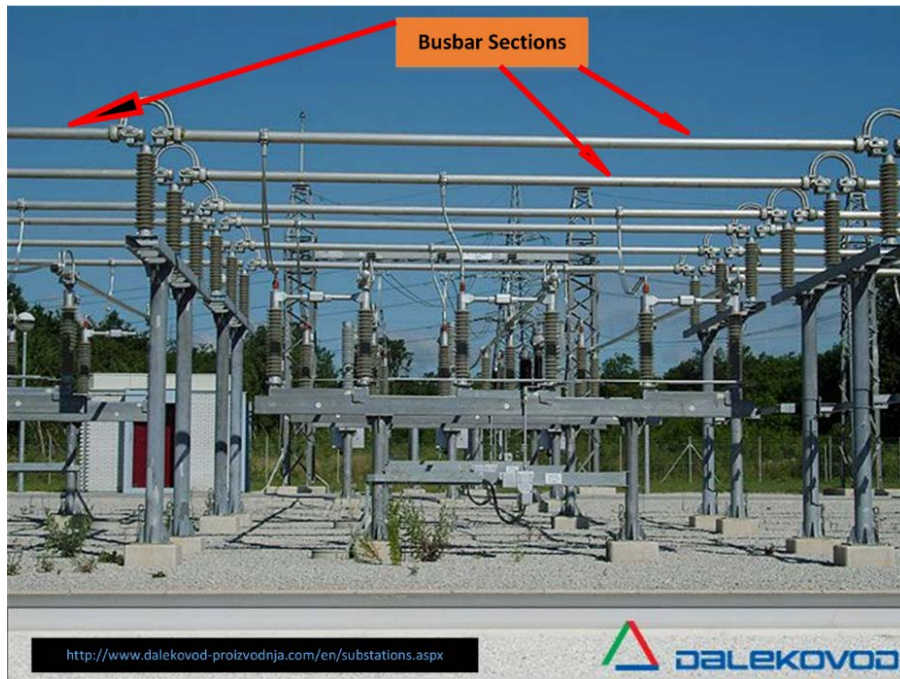

Figure 3: Sections of a busbar in an outdoor load area substation.

1.2.6 *Replace Bus Sections*

A new higher rating busbar section can be used to replace the limiting busbar section if uprating of busbars by external cooling is not a viable solution due to prohibitive cost or capacity shortfall.

1.2.7 *Improve Reactive Power Compensation*

Reactive impedances of lines and load often result in a low power factor causing poor transmission and distribution system performance. Capacitors are commonly used to achieve a power factor closer to unity, which helps to improve voltage profile, power transfer capacity/efficiency, and system stability. However, their transfer capacity improvement benefit is only realized upstream of the point of capacitor connection. Therefore, utilities install shunt capacitor banks at the low voltage bus of load area substations in order to gain the reactive power compensation benefits at area substation and its feeding sub-transmission circuits.

1.3 LOWER VOLTAGE DISTRIBUTION SYSTEM

Lower voltage distribution systems bring the electric power from a load area substation to the customer connection points. Three distinct segments of lower voltage distribution systems are: (1) Primary feeders operating at primary voltage (e.g., 4kV, 13kV, 27KV, and 33kV), (2) Distribution transformers that further step down the primary voltage to the secondary cable voltage level, and (3) Secondary cables/feeder operating at low voltage (e.g., 120/208 volts) that serves the customers.

1.3.1 Primary Feeders

Primary distribution feeders emanate from a load area substation and supply power to secondary distribution systems. The estimated range of MCs for Primary Feeders and cost breakout by cost categories are shown in Table III.

Table III: Approximate Marginal Cost (\$/kW) of Primary Feeder Wires Options

Cost	Load Transfer	Replace Feeder Sections	De-Bifurcate Feeders	New Feeders	Reactive Power Compensation
Marginal Cost (\$/kW)	>9	30-260	>50	>90	>40
Materials & Equipment (%)	40	25-40	55	35	35-70
Labor (%)	45	10-65	30	50	20-35
Others (%)	15	10-50	15	15	10-30
Contingency (Add %)	10	10-80	10	10	10-80

1.3.1.1 Feeder Load Transfer

Similar to load transfer between load area substations, feeder load transfer among feeders of the same area substation is a common practice among utilities. In order to address overload conditions on a feeder, some parts of the overloaded feeder can be transferred to an adjacent feeder that has the capacity to handle the additional load. Normally open and normally closed switch positions in the feeder system are changed to redistribute load among a group of feeders. Equipment costs associated with load transfer includes adding and upgrading segments, switches, reclosers, or other equipment to facilitate the load transfer, but these costs are relatively small.

Sometimes, feeder load transfer is also performed between two feeders that are being supplied from different area substations in order to relieve primary feeder overloading.

1.3.1.2 **Operational Switching Planning**

Operational switching planning is a type of feeder load transfer between feeders that do not require addition and upgrade of line sections and switches. Instead, only the normal state (open or close) of switches is changed to carry out the transfer. Consequently, this solution to meet the load growth does not involve capital investments. The load transfer by switching plan is a temporary retreat to defer reinforcements of small capacity shortfalls (e.g., less than 5%).

1.3.1.3 **Replace Primary Feeder Sections**

Similar to sub-transmission feeder replacements, primary feeder section replacements would be required if a load area substation has the capacity to supply forecasted increased load but the outgoing primary feeder sections are limiting the delivery of power within acceptable loading and voltage limits. Upgrading of feeder section may also call for the replacement of supporting structure (e.g., utility poles).

The feeder section upgrade may be needed in any part of the feeder such as backbone, far-end, or riser. A riser cable is a cable section that is used to connect the two parts of a feeder system that are placed at different heights. Normally, riser cables are placed in an associated structure such as steel conduits or pipes. Figure 4 below shows a riser cable that connects an overhead line to an underground cable.

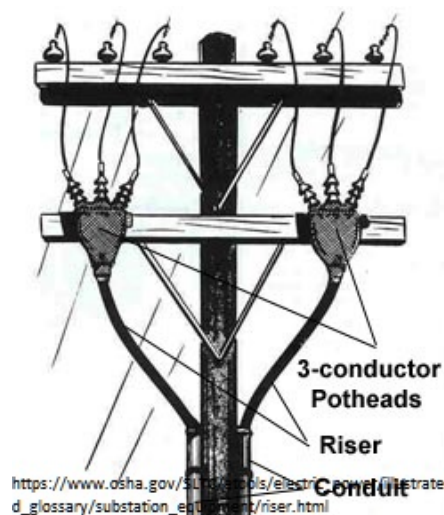

Figure 4: A riser cable connecting an overhead line to an underground cable.

1.3.1.4 De-Bifurcate Feeders

Feeder de-bifurcation is a method in which two feeders that are supplied from a single breaker are divided into two separate feeders with individual breakers. The newly created feeder can utilize the spare feeder position in the load area substation. Figure 5 depicts a feeder de-bifurcation example.

Installation of additional feeders by de-bifurcation provides a more distributed supply to the network and also feeder loading becomes more balanced. Higher numbers of feeders in a particular network reduce the chance of cascading feeder failures, thus increasing reliability. Also, reduced number of components per feeder decreases the exposure to failure.

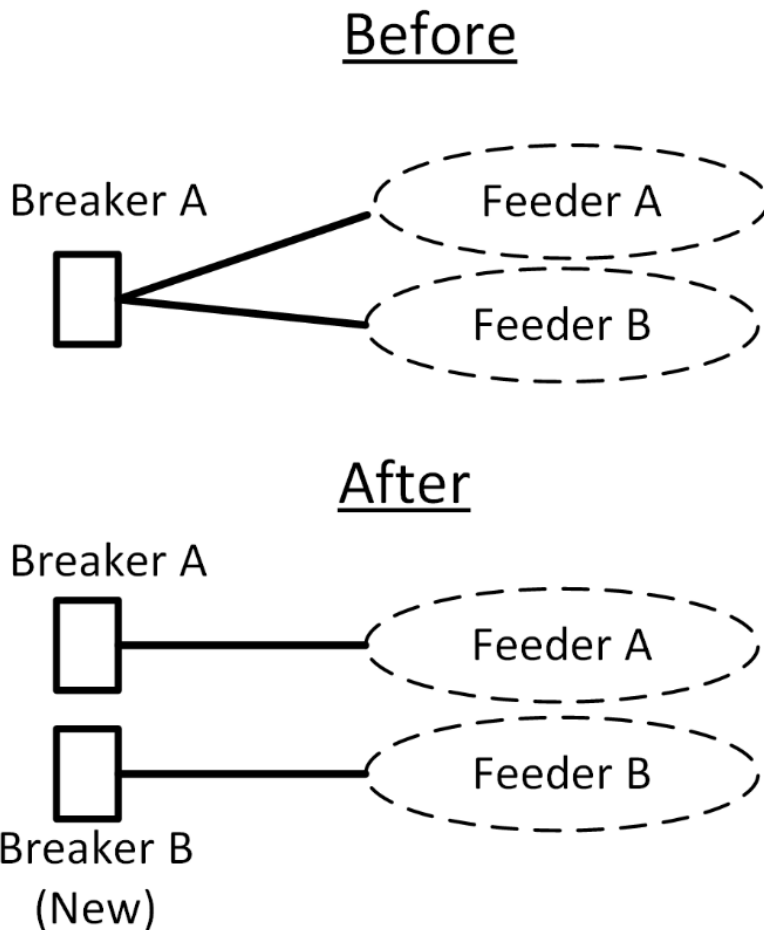

Figure 5: Feeder de-bifurcation.

1.3.1.5 Add New Primary Feeders

The addition of a transformer at a load area substation requires building new feeders originating from the newly installed transformer. Also, the limited rating of a primary feeder currently in operation may require a construction of new feeders to supply the increased load.

1.3.1.6 Improve Reactive Power Compensation

The application of distributed shunt capacitors on primary feeders is a common practice in the electric utility industry for reactive power compensation because the majority of the loads are inductive causing a lagging power factor. Placing capacitor banks near load locations for reactive compensation provides benefits on all the segments of power delivery systems. Normally, distribution utilities use some form of optimization method or rule of thumb to determine the best capacitor location on feeders in order to minimize power loss and optimize voltage regulation along the feeder.

1.3.1.7 Implement Dynamic Feeder Rating (DFR) System

Similar to DFR systems at sub-transmission systems, DFR systems are applied to underground primary feeders which face a marginal overloading problem. This technique can obtain up to 5% of additional load transfer capacity.

1.3.2 Distribution Transformers

Secondary distribution transformers step down primary voltage to customer level voltage (120/208 volts). The estimated range of MCs for adding or replacing distribution transformers and cost breakout by cost categories are shown in Table IV.

Table IV: Approximate Marginal Cost (\$/kW) of Distribution Transformers Projects

Cost	Replace / Add Transformer
Marginal Cost (\$/kW)	40-700
Materials & Equipment (%)	70-80
Labor (%)	15-20
Others (%)	5-15
Contingency (Add %)	10-50

1.3.2.1 *Replace Distribution Transformer*

Overloaded distribution transformers are replaced with new transformers with higher rating. The replacement of underground transformers with new larger ones may require vault enlargement.

1.3.2.2 *Add New Distribution Transformer*

In few load growth situations, a new transformer is installed by establishing a new vault in order to reduce the loading on nearby secondary distribution network transformers.

1.3.3 *Secondary Cable/Feeder*

Secondary cable/feeder connect the low side (120/208 volts) of distribution transformer with customers’ service to supply electricity. The reinforcements of secondary systems are needed in case load growth results in undervoltage or overload problems. Table V lists the approximate MCs of secondary feeder capacity enhancement projects.

Table V: Approximate Marginal Cost (\$/kW) of Secondary Cable/Feeder Projects

Cost	New Feeders / Replace Feeder Section
Marginal Cost (\$/kW)	120-580
Materials & Equipment (%)	25
Labor (%)	15
Others (%)	60
Contingency (Add %)	80

1.3.3.1 *Replace Secondary Sections*

Secondary cable/feeder section replacements are required with a section of a higher rating if existing sections are overloaded.

1.3.3.2 *Add New Secondary Sections*

Additional secondary cable sections are installed in order to decrease the load on existing sections to a level where they are no longer overloaded. Secondary ducts may be needed when sufficient vacant ducts are not available.

Appendix-B: MC Calculation Example (Borough Hall Load Area)

This appendix explains how the 2018 MC is calculated for each of the five cost centers using the Borough Hall Load Area (Load Area Code 01B), located within Brooklyn, as an example. The MC by cost centers for the Borough Hall Load Area is summarized in Table B-1: Borough Hall Marginal Cost by Cost Center, 2018-2027 below.

Table B-1: Borough Hall Marginal Cost by Cost Center, 2018-2027

Cost Center	2018	2019	2020	2021	2022	2023	2024	2025	2026	2027
High Voltage System	\$ -	\$ -	\$ -	\$ -	\$ -	\$ -	\$ -	\$ -	\$ -	\$ -
Area Substation and Sub-transmission	\$ 43	\$ 17	\$ 12	\$ -	\$ -	\$ -	\$ -	\$ -	\$ -	\$ -
Primary Feeder	\$ 122	\$ 94	\$ 63	\$ 30	\$ 33	\$ 36	\$ -	\$ -	\$ -	\$ -
Distribution Transformer	\$ 142	\$ 97	\$ 48	\$ 53	\$ -	\$ -	\$ -	\$ -	\$ -	\$ -
Secondary Cable	\$ 69	\$ 35	\$ 38	\$ -	\$ -	\$ -	\$ -	\$ -	\$ -	\$ -
Total MC	\$ 376	\$ 242	\$ 161	\$ 83	\$ 33	\$ 36	\$ -	\$ -	\$ -	\$ -

The remainder of this appendix will discuss the MC calculation for each of the five cost centers.

1. High Voltage System

The Borough Hall Load Area does not have any High Voltage Systems update plans, hence the value is zero (as shown in Table B-1: Borough Hall Marginal Cost by Cost Center, 2018-2027 above). The only High Voltage Systems update being planned as part of the Study is the Rainey-Corona transmission project. The the Study allocates the cost of this transmission project to the five relevant Load Areas of Long Island City (01Q), Rego Park (03Q), Jamaica (05Q), Flushing (07Q), and Jackson Heights (09Q).

2. Area Substation and Sub-Transmission

The Borough Hall Load Area has three planned area substation (Plymouth Street) upgrades, occurring in 2019 and 2020.

- *Project 1*, online in 2019: Install transformer cooling on all transformers. The project increases the capacity by 39,000 kW and costs \$3,000,000 in 2018.
- *Project 2*, online in 2020: Install additional cooling on Farragut 345/138 kV Transformers 1,2,6,7 & 8 to achieve a rating on the X-winding of at least 622 Amps. The project increases the capacity by 14,000 kW and costs \$2,286,240 in 2020.
- *Project 3*, online in 2020: Replace limiting 138 kV cables associated with Feeders 32072 & 32076 to achieve a SE 300-Hr rating of at least 622 Amps. The project increases the capacity by 14,000 kW and costs \$8,103,000 in 2018 and \$5,647,490 in 2019.

The NPV of the MC is calculated for each project. The MC (in 2018 \$/kW) is calculated as the discounted net cost (i.e., net of residual value) divided by the discounted incremental capacity.

For example, in *Project 3* above, the 14,000 kW capacity added in 2020 would be discounted for 2 years using a WACC of 9.59%, resulting in discounted capacity of 11,657 kW in 2018, 12,775 kW in 2019, and 14,000 kW in 2020. Similarly, discounting the 2018 and 2019 total costs using the 9.59% WACC would result in costs of \$8,103,000 in 2018 and \$5,647,490 in 2019. Since this project involves a replacement of existing equipment, the salvage value is subtracted (which for this Study is conservatively set to zero) from the discounted total cost, resulting in discounted net costs of:

$$\$8,103,000 \times (1 - 0\%) = \$8,103,000 \text{ in 2018}$$

$$\$5,647,490 \times (1 - 0\%) = \$5,647,490 \text{ in 2019}$$

The discounted cost is then divided by the discounted capacity in each year:

$$\frac{\$8,103,000}{11,657 \text{ kW}} = \$1,137/\text{kW} \text{ in 2018}$$

$$\frac{\$5,647,490}{12,775 \text{ kW}} = \$442/\text{kW} \text{ in 2019}$$

The capacity-weighted average of project costs (\$/kW) in each year is then used to calculate the costs at the Plymouth Street area station. Using 2018 discounted net costs as an example, *Project 3* costs \$1,137/kW with a 11,657 kW capacity increase (as calculated above); *Project 2* costs \$163/kW with a 11,657 kW capacity increase; and *Project 1* costs \$84/kW with a 35,587 kW capacity increase. Weighting by capacity, the average discounted net cost for the Plymouth Street area station in 2018 is:

$$\frac{(\$1,137/\text{kW} \times 11,657 \text{ kW}) + (\$163/\text{kW} \times 11,657 \text{ kW}) + (\$84/\text{kW} \times 35,587 \text{ kW})}{11,657 \text{ kW} + 11,657 \text{ kW} + 35,587 \text{ kW}} = \$308/\text{kW}$$

Using analogous calculations, the Plymouth Street discounted net costs (\$/kW) are \$120/kW in 2019 and \$82/kW in 2020. Plymouth Street discounted total costs are equal to discounted net costs since residual value is set to 0%.

The loaders are then applied to these net costs to calculate MCs. Again using 2018 as an example:

$$\begin{aligned} & \text{Discounted Net Cost} \times (1 + \text{Common Plant } \%) \times (\text{Plant A\&G} + \text{ECC}) \\ & + \text{Discounted Total Cost} \times \text{Cost Center O\&M} \times (1 + \text{Non Plant A\&G}) \\ & + \text{Discounted Net Cost} \times (1 + \text{Common Plant } \%) \times (\text{WACC} + \text{Tax Rate}) \times \\ & \quad \text{Working Cap } \% \\ = & \quad \$308/\text{kW} \times (1 + 7.59\%) \times (0.07\% + 9.67\%) \\ & \quad + \$308/\text{kW} \times 3.05\% \times (1 + 3.66\%) \\ & \quad + \$308/\text{kW} \times (1 + 7.59\%) \times (9.59\% + 6.19\%) \times 2.65\% \\ = & \quad \$43/\text{kW} \text{ (as shown in Table B-1)} \end{aligned}$$

Applying the same calculation, the MCs are calculated to be \$17/kW in 2019 and \$12/kW in 2020.

3. Primary Feeders

Primary Feeder upgrade needs are assessed by projecting when the load on individual feeders within the Borough Hall Load Area exceeds its design capacity. The projection assumes the load on individual feeders increases at the same rate as the Load Area's year-to-year load growth from 2016 through 2027.

Taking networked feeder 1B52 as an example: 1B52 has a design capacity of 360 amps, with a 2016 load of 372 amps. Borough Hall's projected year-to-year load growth rates are 12.12% from 2016-2017, and 5.42% from 2017-2018. Applying the year-to-year growth rates to the 2016 load results in projected 2018 load of:

$$372 \times (1 + 12.12\%) \times (1 + 5.42\%) = 440 \text{ amps}$$

440 amps is higher than the feeder's design capacity of 360 amps. Applying the same calculation to the other networked feeders in Borough Hall shows that there are four other feeders (1B56, 1B58, 1B59, and 1B64) that also overload in 2018. Applying the same calculation to non-networked feeders shows that no non-networked feeders overload in 2018.⁵⁷ This projection identifies eleven primary feeder upgrade needs (out of 30 feeders) for the Borough Hall Load Area, as shown in Table B-2: Borough Hall Load Area Primary Feeder Upgrade Needs:

⁵⁷ Con Edison has provided radial feeder forecasts for the Plymouth St area station that corresponds to the Borough Hall (01B) Load Area.

Table B-2: Borough Hall Load Area Primary Feeder Upgrade Needs

Feeder ID	Feeder Type	2016 Load (Amps)	Design Capacity (Amps)	Estimated Loading in 2027	First Year of Overload
1B51	Networked	462	580	600	2020
1B52	Networked	372	360	483	2018
1B53	Networked	222	365	288	N/A
1B54	Networked	343	415	445	2019
1B55	Networked	227	375	295	N/A
1B56	Networked	421	415	547	2018
1B57	Networked	268	323	348	2019
1B58	Networked	310	339	402	2018
1B59	Networked	319	370	414	2018
1B60	Networked	223	341	290	N/A
1B61	Networked	393	465	510	2019
1B62	Networked	458	652	595	N/A
1B63	Networked	364	501	473	N/A
1B64	Networked	333	359	432	2018
1B65	Networked	285	354	370	2020
1B66	Networked	258	351	335	N/A
1B67	Networked	155	339	201	N/A
1B68	Networked	157	441	204	N/A
1B69	Networked	294	394	382	N/A
1B70	Networked	200	340	260	N/A
1B71	Networked	129	415	167	N/A
1B72	Networked	309	395	401	2023
1B73	Networked	161	355	209	N/A
1B91	Radial	102	340	102	N/A
1B92	Radial	108	340	108	N/A
1B93	Radial	98	340	98	N/A
1B94	Radial	44	275	44	N/A
1B95	Radial	129	305	129	N/A
1B96	Radial	160	200	160	N/A
1B97	Radial	111	340	111	N/A

Table B-2: Borough Hall Load Area Primary Feeder Upgrade Needs indicates the needs for upgrades in 2018 (five networked feeders), 2019 (three networked feeders), 2020 (two networked feeders), and 2023 (one networked feeder). An upgrade on any networked feeder is assumed to also reduce load on all other networked feeders in the Load Area, so only one primary feeder upgrade is projected in 2018. The combined feeder upgrade needs identified in Table B-2: Borough Hall Load Area Primary Feeder Upgrade Needs will culminate to five feeder upgrade needs, as shown in Table B-3: Combined Feeder Upgrade Needs for the Borough Hall Load Area below:

Table B-3: Combined Feeder Upgrade Needs for the Borough Hall Load Area

Year of Upgrade	Feeder Type	Feeder IDs
2018	Networked	1B52
		1B56
		1B58
		1B59
		1B64
2019	Networked	1B54
		1B57
		1B61
2020	Networked	1B51
		1B65
2023	Networked	1B72

The cost of the upgrade—before discounting—for the Borough Hall Load Area primary feeders is determined by taking the capacity-weighted average costs from historical primary projects in the Brooklyn-Queens (BQ) borough grouping. This cost is \$271/kW before adjusting for the residual value (total cost). For primary feeders, residual value is again set to 0% of total cost, so net cost is also \$271/kW. These costs are incurred in 2018, 2019, 2020, and 2023. Discounting using a 9.59% WACC yields discounted costs of \$914/kW in 2018.

The loaders are then applied to the discounted costs to calculate the MC in 2018:

$$\begin{aligned}
 &= \$914/kW \times (1 + 7.59\%) \times (0.00\% + 9.67\%) \\
 &\quad + \$914/kW \times 2.37\% \times (1 + 3.66\%) \\
 &\quad + \$914/kW \times (1 + 7.59\%) \times (9.59\% + 6.19\%) \times 2.65\% \\
 &= \$122/kW \text{ (as shown in Table B-1)}
 \end{aligned}$$

The MCs in the other years are \$94/kW in 2019, \$63/kW in 2020, \$30/kW in 2021, \$33/kW in 2022, and \$36/kW in 2023.

4. Distribution Transformers

Distribution Transformer upgrades are assumed to occur whenever cumulative projected load growth over the ten-year study period exceeds the MW-threshold that was calculated using historical observations. This MW-threshold is a measure of how much projected load growth, on average, has historically triggered a new investment, and is then applied to future load growth projections to estimate when a future upgrade would occur. There are twenty load areas in the BQ borough group, and there have been 23 Load Relief projects and eight New Business projects (see Table B-4: Historical BQ Distribution Transformer Projects from Load Relief and New Business below).

Table B-4: Historical BQ Distribution Transformer Projects from Load Relief and New Business

Historical Data				Calculated from Historical Data		
Load Area Code	Involves Replacement?	Capacity Increase (kW)	Total Installation Cost (\$)	Net Installation Cost (\$)	Total Cost per Incremental Capacity (\$/kW)	Net Cost per Incremental Capacity (\$/kW)
[1]	[2]	[3]	[4]	[5]	[6]	[7]
Load Relief Data						
01B	No	750	\$463,858	\$463,858	\$618	\$618
02B	No	770	\$245,369	\$245,369	\$319	\$319
05B	No	740	\$191,892	\$191,892	\$259	\$259
05B	No	740	\$331,487	\$331,487	\$448	\$448
05B	No	740	\$473,121	\$473,121	\$639	\$639
06B	No	770	\$331,587	\$331,587	\$431	\$431
06B	No	770	\$327,349	\$327,349	\$425	\$425
06B	No	1,550	\$422,455	\$422,455	\$273	\$273
06B	No	770	\$388,677	\$388,677	\$505	\$505
06B	Yes	770	\$462,535	\$462,535	\$601	\$601
07B	No	770	\$282,455	\$282,455	\$367	\$367
08B	No	770	\$314,303	\$314,303	\$408	\$408
08B	No	770	\$292,039	\$292,039	\$379	\$379
09B	No	760	\$292,911	\$292,911	\$385	\$385
09B	No	760	\$305,961	\$305,961	\$403	\$403
12B	No	760	\$322,205	\$322,205	\$424	\$424
12B	No	760	\$227,168	\$227,168	\$299	\$299
12B	No	760	\$296,515	\$296,515	\$390	\$390
01Q	No	770	\$272,288	\$272,288	\$354	\$354
01Q	No	770	\$237,596	\$237,596	\$309	\$309
07Q	No	760	\$405,927	\$405,927	\$534	\$534
07Q	No	760	\$257,829	\$257,829	\$339	\$339
09Q	No	790	\$303,311	\$303,311	\$384	\$384
New Business Projects						
02B	No	2,331	\$609,972	\$609,972	\$262	\$262
05B	No	3,587	\$622,431	\$622,431	\$174	\$174
06B	No	1,359	\$468,793	\$468,793	\$345	\$345
02Q	No	1,988	\$624,645	\$624,645	\$314	\$314
03Q	No	306	\$579,829	\$579,829	\$1,895	\$1,895
06Q	No	447	\$290,398	\$290,398	\$650	\$650
07Q	No	839	\$754,335	\$754,335	\$899	\$899
09Q	No	1,162	\$297,524	\$297,524	\$256	\$256

The cost of the upgrade for the Borough Hall Load Area transformers is again determined by taking the capacity-weighted average of costs from historical projects in the BQ borough group. The average of costs in column [6] in Table B-4: Historical BQ Distribution Transformer Projects from Load Relief and New Business above yields a total cost of \$385/kW. Average net cost is the same, at \$385/kW.

Table B-5: Load Growth Trigger for One Distribution Transformer Project at BQ

Data Source	Upgrades per Load Area <i>Count</i>	Historical Load Growth <i>MW</i>	Load Growth for One Project <i>MW</i>
Load Relief	1.15	11.65	10.13
New Business	0.40	6.76	16.89
Overall			11.88

The historical MW growth forecasts for the years the historical upgrade samples are taken from are then observed to calculate the MW load growth forecasts that triggers one transformer upgrade. This calculation is shown in Table B-5: Load Growth Trigger for One Distribution Transformer Project at BQ above. The field “Upgrades per Load Area” is calculated from historical upgrade data in Table B-4: Historical BQ Distribution Transformer Projects from Load Relief and New Business by dividing the number of projects by the number of load areas:

$$23/20 = 1.15 \text{ Load Relief projects per Load Area in 2015 – 2017}$$

$$8/20 = 0.40 \text{ New Business projects per Load Area in 2016 – 2017}$$

The field “Historical Load Growth” is the average borough group cumulative forecasted load growth. The field “Load Growth for One Project” is calculated by dividing historical load growth by upgrade count. Finally, the Overall Load Growth for One Project (11.88 MW) is the average of the Load Relief and New Business values, weighted on upgrade count. This is the MW-threshold value used for the forward-looking upgrade analysis.

Table B-6: Borough Hall Projected Transformer Upgrade Needs, 2018-2027

Year	Cumulative Projected Growth <i>MW</i>	Upgrade Cost <i>\$/kW</i>
2018	17.43	\$385
2019	30.70	\$385
2020	40.53	
2021	42.77	\$385
2022	44.21	
2023	45.42	
2024	46.63	
2025	48.04	
2026	49.55	
2027	50.82	

Table B-6: Borough Hall Projected Transformer Upgrade Needs, 2018-2027 above shows the cumulative projected load growth for Borough Hall in the study period; upgrade years are highlighted in light grey. In 2018, the projected load growth from 2017 to 2018 is 17.43 MW, which is higher than the 11.88 MW threshold calculated above—therefore a transformer upgrade is projected in that year. In 2019, the projected load growth since the previous upgrade in 2018 is

$$30.70 \text{ MW} - 17.43 \text{ MW} = 13.27 \text{ MW}$$

13.72 MW is also higher than 11.88 MW, so another upgrade occurs in 2019. In 2020, the projected load growth since the previous upgrade in 2019 is

$$40.53 \text{ MW} - 30.70 \text{ MW} = 9.83 \text{ MW}$$

This is lower than 11.88 MW so no upgrade is projected in this year. Finally, in 2021, the projected load growth since the 2019 upgrade is

$$42.77 \text{ MW} - 30.70 \text{ MW} = 12.06 \text{ MW}$$

so another upgrade is projected in this year. No more upgrades are assumed through 2027 because the forecast load never hits the next MW-threshold.

The \$385/kW cost incurs in 2018, 2019, and 2021. Discounting using a 9.59% WACC yields discounted costs of \$1030/kW in 2018, \$706/kW in 2019, \$352/kW in 2020, and \$385/kW in 2021.

The loaders are then applied to discounted costs to calculate the MC in 2018:

$$\begin{aligned} &= \$1030/kW \times (1 + 7.59\%) \times (0.07\% + 9.67\%) \\ &\quad + \$1030/kW \times 2.73\% \times (1 + 3.66\%) \\ &\quad + \$1030/kW \times (1 + 7.59\%) \times (9.59\% + 6.19\%) \times 2.65\% \\ &= \$142/kW \text{ (as shown in Table B-1)} \end{aligned}$$

The MCs in the other years are \$97/kW in 2019, \$48/kW in 2020, and \$53/kW in 2021.

5. Secondary Cables

Secondary cable calculations are analogous to transformer calculations. Frequency of upgrades is calculated by borough group. There are twenty Load Areas in BQ, and there have been one Load Relief project and eighteen New Business projects (see Table B-7: Historical BQ Secondary Cable Projects from Load Relief and New Business below). Load Relief data is from 2015-2017 (inclusive) and New Business data is from 2016.

Table B-7: Historical BQ Secondary Cable Projects from Load Relief and New Business

Historical Data				Calculated from Historical Data		
Load Area Code	Involves Replacement?	Capacity Increase (kW)	Total Installation Cost (\$)	Net Installation Cost (\$)	Total Cost per Incremental Capacity (\$/kW)	Net Cost per Incremental Capacity (\$/kW)
[1]	[2]	[3]	[4]	[5]	[6]	[7]
Load Relief Projects						
06B	Yes	770	\$254,232	\$254,232	\$330	\$330
New Business Projects						
01B	Yes	7,965	\$2,366,079	\$2,366,079	\$297	\$297
02B	Yes	2,580	\$822,984	\$822,984	\$319	\$319
03B	Yes	2,483	\$874,421	\$874,421	\$352	\$352
04B	Yes	2,036	\$617,238	\$617,238	\$303	\$303
05B	Yes	3,606	\$1,131,603	\$1,131,603	\$314	\$314
06B	Yes	11,146	\$2,983,317	\$2,983,317	\$268	\$268
07B	Yes	257	\$154,310	\$154,310	\$600	\$600
08B	No	6,203	\$1,543,095	\$1,543,095	\$249	\$249
09B	No	3,144	\$771,548	\$771,548	\$245	\$245
10B	No	3,144	\$771,548	\$771,548	\$245	\$245
01Q	No	4,402	\$1,080,167	\$1,080,167	\$245	\$245
02Q	No	5,659	\$1,388,786	\$1,388,786	\$245	\$245
03Q	No	1,591	\$411,492	\$411,492	\$259	\$259
05Q	No	838	\$205,746	\$205,746	\$245	\$245
06Q	No	419	\$102,873	\$102,873	\$245	\$245
07Q	Yes	855	\$257,183	\$257,183	\$301	\$301
09Q	No	419	\$102,873	\$102,873	\$245	\$245
10Q	No	419	\$102,873	\$102,873	\$245	\$245

The cost of the upgrade is again determined by taking the capacity-weighted average of costs from historical projects in BQ. The Study calculates the average of column [6] in Table B-7: Historical BQ Secondary Cable Projects from Load Relief and New Business above, yielding a total cost of \$277/kW before removal of residual value. Average net cost is the same, at \$277/kW.

Table B-8: Load Growth Trigger for One Secondary Project at BQ

Data Source	Upgrades per Load Area Count	Historical Load Growth MW	Load Growth for One Project MW
Load Relief	0.05	11.65	233.08
New Business	0.90	2.37	2.63
Overall			14.76

First, the average number of projects per Load Area in the historical sample years is calculated:

$$1/20 = 0.05 \text{ Load Relief projects per Load Area in 2015, 2016, and 2017}$$

$$18/20 = 0.90 \text{ New Business projects per Load Area in 2016}$$

Then the historical MW growth forecasts in the years the historical project samples are from are observed to calculate the MW load growth that triggers one secondary cable upgrade. Table B-8: Load Growth Trigger for One Secondary Project at BQ above shows the overall load growth projection that triggers one new investment is 14.76 MW.

Table B-9: Borough Hall Projected Secondary Upgrade Needs, 2018-2027

Year	Cumulative Projected Growth MW	Upgrade Cost \$/kW
2018	17.43	\$277
2019	30.70	
2020	40.53	\$277
2021	42.77	
2022	44.21	
2023	45.42	
2024	46.63	
2025	48.04	
2026	49.55	
2027	50.82	

Table B-9: Borough Hall Projected Secondary Upgrade Needs, 2018-2027 above shows when secondary cable upgrades are projected to take place based on projected cumulative load growth. The process for determining upgrade timing is the same as that for transformers, but the 14.76 MW threshold is applied rather than the 11.88 MW threshold.

As shown in the table, the \$277/kW cost is incurred in 2018 and 2020. Discounting using a 9.59% WACC yields discounted costs of \$507/kW in 2018, \$252/kW in 2019, and \$277/kW in 2020.

The loaders are then applied to discounted costs to calculate the marginal cost in 2018:

$$\begin{aligned}
 &= \$507/kW \times (1 + 7.59\%) \times (0.00\% + 9.67\%) \\
 &\quad + \$507/kW \times 2.73\% \times (1 + 3.66\%) \\
 &\quad + \$507/kW \times (1 + 7.59\%) \times (9.59\% + 6.19\%) \times 2.65\% \\
 &= \$69/kW \text{ (as shown in Table B-1)}
 \end{aligned}$$

The MCs in the other years are \$35/kW in 2019 and \$38/kW in 2020.

Appendix-C: Loaders

This appendix compares the Loaders values to those used in previous MCCOS. Table C-1: Comparison of Loaders Used in Current and Past Studies below summarizes the loaders from this Study.

Table C-1: Comparison of Loaders Used in Current and Past Studies

Loader	2012	2015	2018
Plant A&G	0.07%	0.08%	0.07%
Common Plant %	6.82%	7.16%	7.59%
Economic Carrying Charge	11.62%	11.22%	9.67%
Working Capital % of Electric PIS	2.61%	2.48%	2.65%
Income Tax Rate	3.34%	4.64%	6.19%
Regulated WACC	7.79%	7.08%	9.59%
Non-Plant A&G	2.45%	3.43%	3.66%
Revenue Requirement for Working Capital	11.13%	11.72%	15.78%

Appendix-D: Grouping Approaches

This appendix discusses the different grouping approaches explored for this Study and how the thresholds used were derived.

Understanding that costs (derived as a function of the Load Area's borough) and load growths are the fundamental drivers, the Study examines a number of grouping approaches with varying additional drivers considered. Load growth is measured either as a percentage growth rate (using the compound annual growth rate, or CAGR) or as an absolute value in MW. Load Areas are grouped together by load growth (high or low) and several thresholds for determining this high and low split is examined. Additional drivers include the Load Profile (as discussed in Section III: Grouping for the VDER Proceeding of the main report and Appendix-E: Load Profile Clustering), higher voltage cost center upgrades identified in the LRP, and distinction by topology (network vs. radial systems). Combining these variables, a total of seven grouping approaches using different key fundamental drivers as listed below are analyzed:

- Grouping Approach 1: Borough + Ten Year Cumulative MW Load Growth
- Grouping Approach 2: Borough + Ten Year Load Growth (CAGR) Only
- Grouping Approach 3: Borough + LRP Upgrade + Cumulative MW Load Growth
- Grouping Approach 4: Borough + Cumulative MW Load Growth + LRP Upgrade
- Grouping Approach 5: Borough + Load Shape
- Grouping Approach 6: Borough + Cumulative MW Load Growth + Load Shape
- Grouping Approach 7: Borough + Network vs Radial + Load Shape + Cumulative MW Load Growth

To compare the effectiveness of the different grouping approaches and load threshold, the standard deviation of the MCs within each group is analyzed. A smaller standard deviation indicates a tighter group. In addition, the standard deviation among grouping approaches is compared. A larger value indicates more distinct groupings. However, as in most data analysis, an outlier could impact the results. Figure D-1: Cumulative Ten Year MW Load Growth by Load Area plots the 84 Load Areas' load growth and identifies two potential outliers.

Figure D-1: Cumulative Ten Year MW Load Growth by Load Area

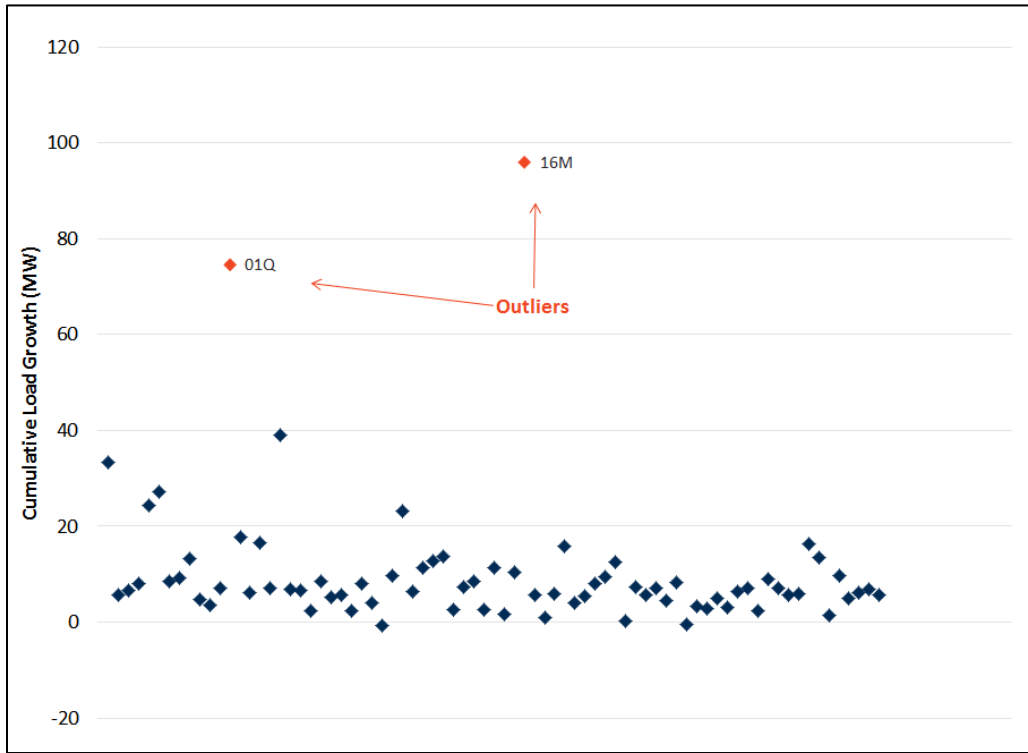

Table D-1: Standard Deviation by Grouping Approach and MW Threshold: Excluding Outliers below summarizes the standard deviation of the MCs within each group. The analysis indicates that Grouping Approaches 1 through 3 show the lowest standard deviation using a 10 MW threshold while Grouping Approaches 6 and 7 show the lowest standard deviation using a 20 MW threshold. Grouping Approach 6 using a 20 MW threshold also shows a lower standard deviation than those observed in Grouping Approaches 1 through 3 using a 10 MW threshold.

Table D-1: Standard Deviation by Grouping Approach and MW Threshold: Excluding Outliers

Grouping Approach	Standard Deviation Within Groups (\$/kW)		
	10 MW	20 MW	30 MW
Grouping Approach 1: Ten Year Cumulative MW Load Growth	\$57.49	\$61.10	\$61.18
Grouping Approach 2: Ten Year CAGR*	\$63.61	\$74.94	\$76.82
Grouping Approach 3: LRP Upgrade + MW Load Growth	\$61.08	\$67.32	\$71.63
Grouping Approach 4: MW Load Growth + LRP Upgrade		\$49.58	
Grouping Approach 5: Load Shape		\$71.79	
Grouping Approach 6: MW Load Growth + Load Shape	\$56.64	\$55.07	\$55.91
Grouping Approach 7: Network/Radial + Load Shape + MW Load Growth	\$71.31	\$61.07	\$64.56

Notes: Bolded values indicate the MW-threshold that yields the lowest variation within groups for each Grouping Approach. Grouping Approaches 4 and 5 do not depend on MW threshold, so only one value is reported.

*The 10 MW threshold roughly corresponds to a 0.75% CAGR threshold; each 10 MW change corresponds to a 0.30% change in CAGR.

Table D-2: Group Summaries by Grouping Approach with 20 MW Threshold: Excluding Outliers below summarizes the standard deviation within and among the groups using a 20 MW threshold. The analysis indicates that Grouping Approach 6 has one of the lowest standard deviation (second lowest) within a group and also one of the highest (second highest) standard deviation among groups.

Table D-2: Group Summaries by Grouping Approach with 20 MW Threshold: Excluding Outliers

Grouping Approach	Number of Groups	Range in Group Size		Distance Within and Among Groups	
		Load Area Count	2016 Total Peak Load MW	Average Standard Deviation of 2018 MC Within Groups \$/kW	Standard Deviation of 2018 Group Average MCs \$/kW
Grouping Approach 1: Ten Year Cumulative MW Load Growth	6	2 - 43	347 - 5,768	\$61.10	\$109.75
Grouping Approach 2: Ten Year CAGR	6	3 - 41	532 - 5,574	\$74.94	\$70.02
Grouping Approach 3: LRP Upgrade + Cumulative MW Load Growth	9	1 - 42	149 - 5,619	\$67.32	\$80.35
Grouping Approach 4: Cumulative MW Load Growth + LRP Upgrade	10	1 - 35	149 - 4,461	\$49.58	\$95.23
Grouping Approach 5: Load Shape	8	1 - 24	59 - 4,020	\$71.79	\$92.90
Grouping Approach 6: Cumulative MW Load Growth + Load Shape	10	1 - 24	59 - 4,020	\$55.07	\$111.91
Grouping Approach 7: Network vs Radial + Load Shape + Cumulative MW Load Growth	6	2 - 35	347 - 6,547	\$61.07	\$120.46

Appendix-E: Load Profile Clustering

This appendix discusses the approach used to cluster the Load Areas by hourly load profiles. The goal of this clustering exercise is to group the Load Areas based on their normalized peak day loads (on a scale of 0 to 100 percent of peak load on that day), as part of the overall grouping exercise discussed in Appendix D: Grouping Approaches. The load profiles by themselves may not contribute much to identifying load growth or associated investments to accommodate load growth. However, characteristic load shapes provide a proxy for the combined factors of load factor, timing of peak, and length of peak. These factors combined could be distinct enough to serve as a proxy for similar types of investment requirements/types (i.e., indicate DER types that are most beneficial for a given load profile cluster), which may become important for the VDER procedure.

The clustering is performed for the hourly loads profile of all Load Areas, using an average peak day for each Load Area.^{58 59} The hourly profile data is first normalized on a scale of 0 to 100 percent of peak load on that day. Then using the R model (a software environment for statistical computing and graphic), clustering is performed using statistical k-means approach.⁶⁰

A. USING THE R PACKAGE KML TO CLUSTER HOURLY LOAD DATA

The set of normalized loads over 24 hours for each Load Area is called a set of trajectories. The KML algorithm assigns each trajectory to one of k clusters. The center of each cluster is determined, in a phase called the “Expectation” phase. Then, each trajectory is assigned to its “nearest” cluster in the “Maximization” phase. The Expectation and Maximization phases are repeated alternately until equilibrium is reached—i.e. no more changes occur in the clusters.

KmL allows the user to specify the distance measure used when determining the “nearest” cluster, such as Euclidean distance or Manhattan distance. The distance measures calculate the distance between observations—hourly loads, in this Study—at each time t . For this Study, the Euclidean distance (which is the default distance measure) is used and implemented into the KmL algorithm.

The optimal number of clusters is the number that maximizes distance between trajectories in different clusters, and minimizes distance between trajectories within a cluster. By default, KmL divides the data into clusters of two, then three, all the way up to six, and chooses the optimal

⁵⁸ An average peak day is based on a temperature variable of 86 degrees Fahrenheit.

⁵⁹ Historical data was only available for the combined Load Areas for Washington Street (later split into 01W and 09W) and Granite Hill (later split into 10W and 15W), and therefore the load profile analysis is performed for 82 Load Areas.

⁶⁰ Further details of R are available at <https://www.r-project.org/>

number of clusters. The algorithm determined three to be the optimal number of clusters for the 82 Load Area trajectories.

The starting condition can also be specified, and these conditions can lead to very different clusters. Figure E-1: Effect of Starting Condition on Clusters below illustrates how the set of trajectories in (a) can lead to different partitions shown as (b) through (d), depending on the starting conditions:

Figure E-1: Effect of Starting Condition on Clusters

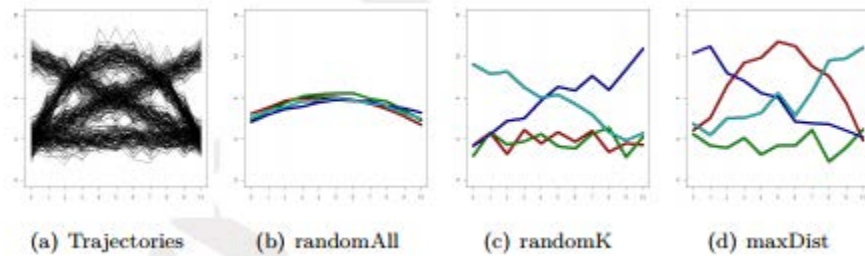

Source: Genolini, Christopher and Bruno Falissard, "KmL: A Package to Cluster Longitudinal Data," Available at:

<http://christophe.genolini.free.fr/recherche/aTelecharger/genolini2011.pdf>

The Study explored both the “nearlyAll” starting condition (the default) and the “maxDist” starting condition. Both starting conditions resulted in assigning each Load Area to the same clusters.

B. LOAD AREA CLUSTERING RESULTS

Figure E-2: Hourly Load Trajectories and Clusters below summarizes the clustering results from running the KmL algorithm using the hourly trajectories. The black lines in this figure shows the 82 individual Load Area trajectories, and the colored lines show the centers of each of the three clusters.

Figure E-2: Hourly Load Trajectories and Clusters

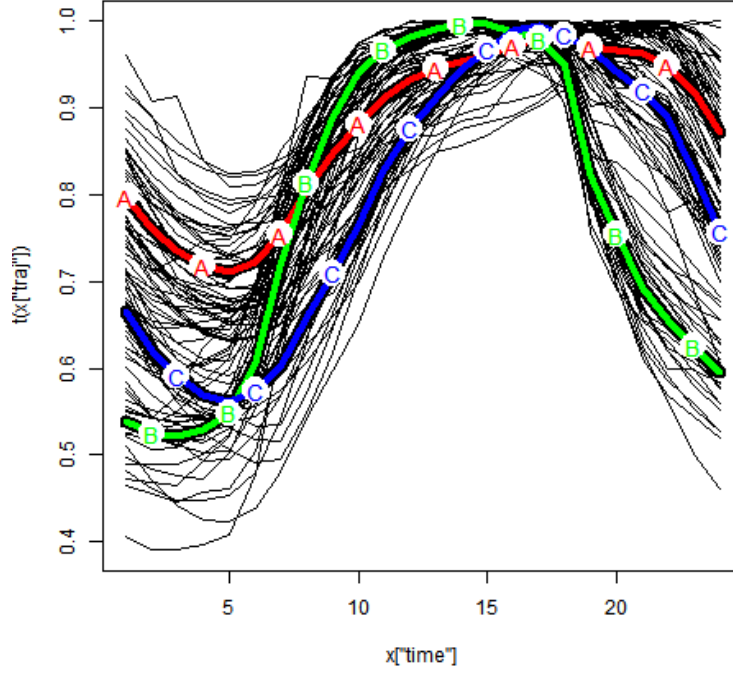

Table E-1: Load Areas per Cluster below shows the breakdown of the Load Areas in each cluster.

Table E-1: Load Areas per Cluster

Cluster	Number of Load Areas in Cluster	Percent of Load Areas in Cluster
1	42	51%
2	22	27%
3	18	22%

Appendix-F: Public Meeting Materials

The Study included the following five public meetings. Materials presented through these meetings are included in this Appendix.

- Initial Stakeholder Meeting Presentation (July 20, 2017)
- Presentation to the New York Department of Public Service Stakeholder Meeting (October 10, 2017)
- Interim Stakeholder Meeting Presentation (October 23, 2017)
- Presentation to the New York Department of Public Service Stakeholder Meeting (February 9, 2018)
- Final Stakeholder Meeting Presentation (TBD) ⁶¹

⁶¹ The final stakeholder meeting has not taken place yet and the presentation will be appended at a later date.

INITIAL STAKEHOLDER MEETING PRESENTATION (JULY 20, 2017)

Con Edison Marginal Cost Study Overview

Stakeholder Meeting

PRESENTED TO

Con Edison Stakeholders

PRESENTED BY

Philip Hanser
Bruce Tsuchida
Pearl Donohoo-Vallett
Jens Schoene (on phone)

July 20, 2017



Copyright © 2017 The Brattle Group, Inc.

Disclaimer

This presentation, designed for an interactive meeting with Con Edison staff and stakeholders, is intended to assist in developing an informed view on the proposed marginal cost-based cost of study approach. This presentation and associated meeting are not meant or permitted to be a substitute for the exercise of Con Edison's or any other stakeholder's own business judgment. The Brattle Group cannot, and does not, accept liability under any theory for losses suffered, whether direct or consequential, arising from any reliance on this presentation, and cannot be held responsible if any conclusions drawn from this presentation should prove to be inaccurate.

Agenda

Project Tasks

Marginal Cost Calculation Approach

Open Discussion

Agenda

Project Tasks

Marginal Cost Calculation Approach

Open Discussion

Overview of Tasks

Task 1: Methodology and Stakeholder Involvement

- Review existing calculation methodologies and data used
- Design a new and more granular calculation method

Task 2: Data Gathering and Analysis

- Collect data to actually perform the calculation
- Build marginal cost-based cost of service study (MCCOS) model using the new calculation methodology including modifications needs identified

Task 3: Marginal Cost Results

- Summarize the results into a final report

Agenda

Project Tasks

Marginal Cost Calculation Approach

Open Discussion

Project Overview (1/3)

Con Edison has tasked Brattle with developing a locational Marginal Cost-based Cost of Service Study (MCCOS) approach to support the Value of Distributed Energy Resources (VDER) proceedings

- Prior study provided a system-average value, which Staff determined was insufficient to support the Reforming the Energy Vision (REV) goals
- Brattle and EnerNex will be developing an approach for more granular (network-level) marginal costs
- The resulting MCCOS will allow the company to set values for multiple Locational System Relief Value areas (LSRVs), replacing the current binary “stretch” and “squeeze” approach

MCCOS will focus on marginal costs due to incremental load growth

Project Overview (2/3)

We propose to follow a System Planning approach to develop marginal costs for several representative network types

- The basic question in calculating electric marginal costs is “What is the least cost means of meeting an increase in demand without jeopardizing the level of reliability?”
 - For generation, this has resulted in two approaches
 - NERA’s peaker method
 - Peaker *a priori* determined to be the least incremental cost response
 - The system planning method
 - Answers the question “How would a system planner respond to a change in load?”
 - The system planning approach examines a range of available options to meet an increase in load while maintaining the same level of reliability
 - Marginal costs are the difference between the current system and the system configured to meet the additional demand

Marginal Cost Calculation Approach
Project Overview (3/3)

We propose to follow a System Planning approach to develop marginal costs for several representative network types

- The distribution system is more heterogeneous than generation
 - How a distribution system planner would respond depends on the current state of the specific portion of the distribution system under consideration
 - The approach differs substantially across second-contingency networks and first-contingency non-networked areas
- Con Edison's 65 networks and 19 non-networked areas will be grouped for analysis based on operating levels relative to rated capacities
 - Not all regions have positive MCs due to current existing capacity
 - For those that do, we expect there will be a range of potential MCs

Marginal Cost Calculation Approach
Proposed Methodology - Definition

- Marginal Cost-based Cost of Service Study
 - Identifies the cost associated with capacity upgrade needed in order to deliver the additional power to the customers without surpassing grid limits
 - Definition: the cost (\$) of delivering one additional unit (kW) of load
 - The marginal cost is zero for segments built with excess capacity
- The above will be analyzed on a network level (rather than at the system level)
 - The asset in need of capacity upgrade is unknown and may vary by network
 - Detailed data/information about each network's assets and Con Edison's asset upgrade practice will be used
- Assumptions
 - Incremental load growth triggers additional capacity needs
 - Impact of DERs included in load forecast
 - Networks with similar characteristics can be grouped

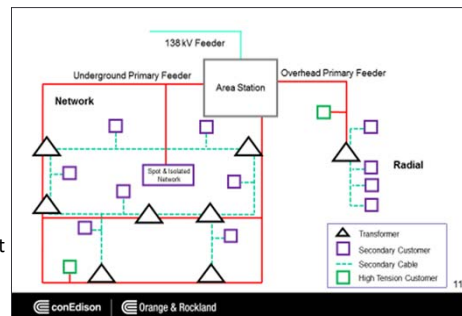

Proposed Methodology – Information Needs

Engineering Practices/Standards

- *Loading limits* for different *segments* of the distribution system
- *Upgrade practices*
- *Estimated costs* associated with the *upgrades*
 - *Review of five year Con Edison's distribution investment plans*

Some data will need to be developed using typical data (if Con Edison cannot provide the data) to be used in the MCCOS model

- Example: A transformer's summer (weather/time dependent) normal and emergency loading limits are 10 MW and 13 MW, respectively
 - How were these limits defined?
 - Engineering/operational experience-based judgments or manufacturer specifications?
 - Can we apply the observation to other transformers, and if so, how?
 - Multiplier vs. adder
 - Are there exceptions to applying these analyses?
 - For example, these analyses may apply only to transformers within a certain capacity range

Agenda

Project Tasks

Marginal Cost Calculation Approach

Open Discussion

Discussion



Project Point of Contact:

Yan Flishenbaum

flishenbaumy@coned.com

Team Biographies

The Brattle Group

PHIL HANSER
Principal | Boston



Mr. Hanser is a principal of The Brattle Group and has over thirty-five years of consulting and litigation experience in the energy industry. He has appeared as an expert witness before the U.S. Federal Energy Regulatory Commission (FERC), state public utility commissions, environmental agencies, Canadian utility boards, as well as arbitration panels, and in federal and state courts.

BRUCE TSUCHIDA
Principal | Boston



Mr. T. Bruce Tsuchida has over 25 years of experience in utility operations, power market analysis, and new technology development for both domestic and international markets. He has been leading several studies of renewable integration and the associated changes in utility business models for island utilities where the distinction between transmission and distribution does not exist.

PEARL DONOHOO-VALLETT
Associate | Washington D.C.



Dr. Pearl Donohoo-Vallett has expertise clean energy policy, utility regulatory ratemaking, and transmission planning. She has familiarity with the New York power system and related policies through prior modeling on the New York City 80X50 project and the New York Clean Energy Standard.

JENS SCHOENE
Director of Research Studies



Dr. Schoene has over 10 years power industry experience and has led and participated in studies on integration of renewable generation in distribution systems; transients, harmonics, and TOVs in wind plants and other power systems; power quality measurements; and inductive coupling in distribution systems.

EnerNex

MUHAMMAD HUMAYUN
Senior Consultant



Dr. Humayun's expertise includes power systems planning, operation, and control; reliability studies, substations, load flow calculation methods, short circuit analysis, and contingency analysis; distribution system planning, operation, and control; protective relaying; and optimization methods applied to power system problems.

VADIM ZHEGLOV
Senior Consultant



Mr. Zheglov has performed studies that identify integration impacts of renewable energy generation on power systems. His expertise is in modeling simulations and integration cost analysis. Mr. Zheglov also performs on-site field measurements on operating power systems ranging from solar and wind power plants to integrated backup power supplies.

About Brattle

The Brattle Group provides consulting and expert testimony in economics, finance, and regulation to corporations, law firms, and governments around the world. We aim for the highest level of client service and quality in our industry.

We are distinguished by our credibility and the clarity of our insights, which arise from the stature of our experts, affiliations with leading international academics and industry specialists, and thoughtful, timely, and transparent work. Our clients value our commitment to providing clear, independent results that withstand critical review.

Brattle Practices

ENERGY & UTILITIES

- Competition & Market Manipulation
- Distributed Energy Resources
- Electric Transmission
- Electricity Market Modeling & Resource Planning
- Energy Litigation
- Environmental Policy, Planning and Compliance
- Finance and Ratemaking
- Gas/Electric Coordination
- Market Design
- Natural Gas & Petroleum
- Nuclear
- Renewable & Alternative Energy

LITIGATION

- Accounting
- Analysis of Market Manipulation
- Antitrust/Competition
- Bankruptcy & Restructuring
- Big Data & Document Analytics
- Commercial Damages
- Environmental Litigation & Regulation
- Intellectual Property
- International Arbitration
- International Trade
- Labor & Employment
- Mergers & Acquisitions Litigation
- Product Liability
- Securities & Finance
- Tax Controversy & Transfer Pricing
- Valuation
- White Collar Investigations & Litigation

INDUSTRIES

- Electric Power
- Financial Institutions
- Natural Gas & Petroleum
- Pharmaceuticals & Medical Devices
- Telecommunications, Internet, and Media
- Transportation
- Water

Brattle Offices



Privileged and Confidential

16 | brattle.com

EnerNex - Experts in Power Systems Analysis, Control, Integration and Smart Grid Technology

- ▶ SBA Small Business Certified
- ▶ Over 65% of employees hold an advanced degree
- ▶ Listed in *Inc. 5000* from 2008 to 2011
- ▶ Winner of the AWEA Technical Achievement Award
- ▶ Winner of UVIG Achievement Award
- ▶ Winner of the Program Management Institute (PMI) Distinguished Project of the Year Award
- ▶ TN *Hot 100* Fast Growing Companies
- ▶ Highly familiar with every aspect of today's power systems as well as the characteristics of emerging technologies that can impact those systems
- ▶ Extensive and diverse electric power industry client base—US Federal, state, and local agencies, utilities, commercial clients, both in the US and internationally

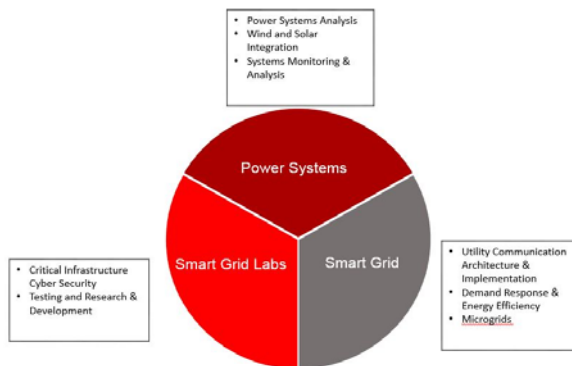

EnerNex Industry Expertise and Capabilities

PRESENTATION TO THE NEW YORK DEPARTMENT OF PUBLIC SERVICE STAKEHOLDER MEETING (OCTOBER 10, 2017)

Consolidated Edison Marginal Cost Study

Study Framework

PRESENTED TO

New York Department of Public Service

PRESENTED BY

Philip Hanser
Bruce Tsuchida
Pearl Donohoo-Vallett
Jens Schoene

October 10, 2017



Copyright © 2017 The Brattle Group, Inc.

Agenda

Project Overview

Calculation Methodology

Clustering

Project Overview

Project Overview

Consolidated Edison has tasked Brattle with developing a locational Marginal Cost-based Cost of Service Study (MCCOS) approach to support the Value of Distributed Energy Resources (VDER) proceedings

- Brattle and EnerNex will be developing an approach for more granular (Network/Load Area level) marginal costs
- Prior study provided an average system-wide value, which the Commission determined was insufficient to support the Reforming the Energy Vision (REV) goals
- The resulting MCCOS will allow the company to set values for multiple Location-Specific Relief Value areas (LSRVs), replacing the current binary “stretch” and “squeeze” approach

MCCOS will focus on marginal costs due to incremental load growth and only assume traditional wires options

- The focus on traditional wires options provides a baseline for comparison to non-wires solutions
- A separate cost-benefit analysis can then be performed for non-wires solutions

System Planning Approach

We propose to follow a System Planning approach to develop marginal costs for several clusters of Networks/Load Areas

- The basic question in calculating electric marginal costs is “What is the least cost means of meeting an increase in demand without jeopardizing the level of reliability?”
- The system planning approach examines a range of available options to meet an increase in load while maintaining the same level of reliability and is aligned with engineering practices
 - Answers the question “How would a system planner respond to a change in load?”
 - Marginal costs are the difference between maintaining the current system and the system configured to meet the additional demand

Consolidated Edison System

Balancing geographic granularity, data availability, and mismatches in planning timelines, Consolidated Edison’s (the Company’s) 65 networks and 19 non-networked areas will be clustered in order to produce cost estimates for groups of Networks/Load Areas

- The Company’s system is not easily separable for analysis due to its mix of radial and networked areas
- Analyzing the smallest separable unit (Network/Load Area), presents data and methodological issues due to both:
 - Limited historical samples of projects
 - Mismatches between the study timeline and distribution planning timelines

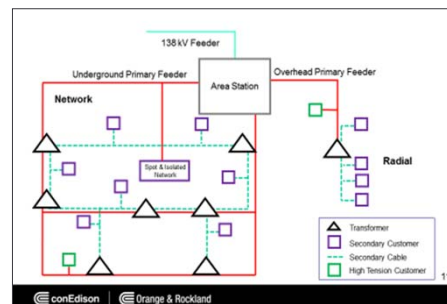

Eight Cost Centers

Past Consolidated Edison studies have used eight cost centers; these cost centers need to be assigned/allocated to Network/Load Area clusters

- Transmission Costs
[higher electrical level than area substation – serves multiple]
 - Switching Station Costs – Transmission functionality
[higher electrical level than area substation – serves multiple]
 - Switching Station Costs – Substation functionality
[higher electrical level than area substation – serves multiple]
 - Area Substation and Sub-transmission Costs
[area substation]
 - Primary Feeder Costs
[network/load area]
 - Distribution Transformer Costs
[network/load area]
 - Secondary Cable Costs
[network/load area]
 - Customer-related costs: services, metering, customer accounting/customer service
- Diagram annotations:
- A bracket groups the first three items (Transmission, Switching Station - Transmission, and Switching Station - Substation) with the label "Split among Area Subs."
 - A bracket groups the last three items (Primary Feeder, Distribution Transformer, and Secondary Cable) with the label "Networks/Load Areas".
 - A bracket groups the last two items (Distribution Transformer and Secondary Cable) with the label "Split among Networks/Load Areas".
 - A red dashed box highlights the "Area Substation and Sub-transmission Costs" item, with the word "Focus" written in red next to it.

Calculation Methodology

General Approach of Calculation

$$\text{Marginal Cost (\$/kW)} = \frac{\text{NPV of Net Cost}}{\text{Capacity Increase}}$$

Net Cost = Investment Cost – Replaced Asset Residual Value

Capacity Increase = Capacity Increase at Contingency Ratings

- Marginal costs will mean the net cost, i.e., new investment cost net of the residual value of the asset that is being replaced/retired to accommodate the increase in load
- Cost will be calculated on an Net Present Value (NPV) basis
- Model/Calculation will cover a ten year period starting 2018 through 2027
- MCCOS model will be developed to perform calculation at the Network/Load Area level granularity
- Inclusion of Net Cost calculation (removal of replaced asset residual value) will decrease marginal costs

Investment Costs

Area substation costs will be based on the Company's Load Area Relief Plan

- Provides area substation projects and timing on a 10-year time horizon

Network/Load Area level costs will be based on historical sampling and budgeting for future years

- Network/Load Area level costs include primary network, transformer, and secondary cable cost centers
- Historical sample spans approximately 3 years (2015-2017)
- Data includes projects to accommodate increasing load from existing customers and increasing load from new customers
- Timing and size of investments by cluster will be based on a combination of budget forecasts and potential needs

Residual Value Calculation (1/2)

The residual values of replaced assets (when applicable) will be estimated using Consolidated Edison's historical data

- Area Substation level and Network/Load Area level projects are divided into two groups: those with asset replacement and those without asset replacement (new assets only)
- The Company does not track residual values for individual assets being replaced are not tracked
- Estimated values for replaced assets will be used based on FERC-account level information
- Residual value will be proportional to average age of asset at replacement

$$\text{Replaced Residual Asset Value (\$)} = \text{New Asset Cost (\$)} \times \text{Approx. Value Remaining (\%)}$$

Residual Value Calculation (2/2)

- The estimated percentage of residual value remaining will be derived from the mapping of FERC-level accounts to the Company's cost centers

$$\text{Approx. Value Remaining (\%)} = \frac{\text{Reproduction Cost Net Depreciation}}{\text{Reproduction Cost}}$$

- Residual value will be proportional to average age of asset at replacement
- Range of residual value remaining is ~5-15% and will reduce marginal costs by approximately this same range as residual values are subtracted from costs

Underground Conductors Average % Remaining Value

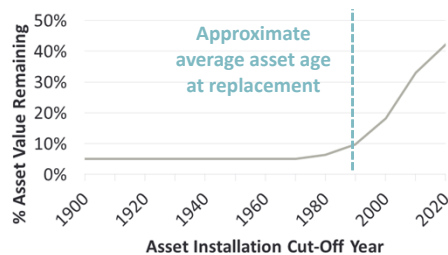

Clustering

Review: Why Cluster?

- The proposed MCCOS approach will calculate marginal costs at a Network/Load Area level rather than at the system level; as such, it must address data mismatch/availability issues:
 - Marginal cost study considers **10 year time horizon**
 - Investments for Network/Load Area level cost centers (primary, transformer, and secondary) are determined on a **~1-3 year time horizon**
 - Historical data is insufficient to produce network-by-network cost (\$/kW) estimates as not all networks/load areas have been upgraded over the past 3 years
- The proposed approach addresses these issues through **clustering of networks**
- The goal is to produce groupings with **similar cost characteristics**

Network/Load Area Level Cost Centers and Data Availability

Cost Center	Planning Horizon	% with Cost Data* in Historical Test Period
Primary Feeder	~1-3 years	~20%
Transformer	~1-3 years	~20%
Secondary Cable	~1-3 years	~60%

Note: *Data does not include finalized historical sample; however, overall sample size is not anticipated to substantially differ from figures presented here

Approach to Clustering

Clustering is an iterative process of selecting appropriate metrics and then clustering Networks/Load Areas according to those metrics

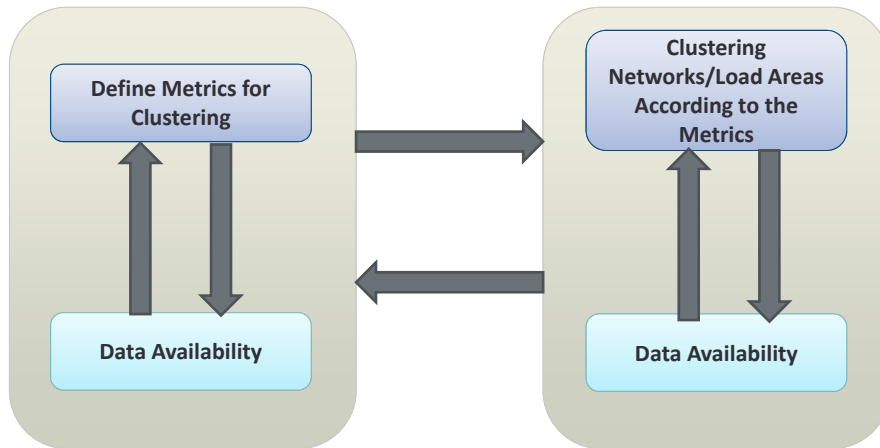

Privileged and Confidential

14 | brattle.com

Network/Load Area Clustering Approaches

- Combinations of metrics for each Network/Load Area can be clustered in several ways
- We have selected two approaches for comparison and potential combination

Hierarchical

Groups load areas using a “tree” approach, allowing grouping to follow “most-to-least” importance of metrics

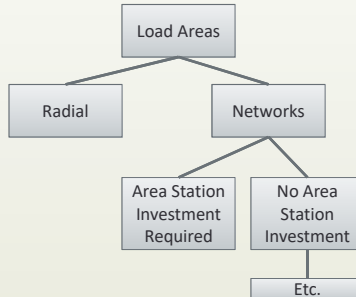

Privileged and Confidential

Statistical (k-means)

Creates an optimal number of groups based on multitude of numbers – does not require ranking of metrics and allows for more holistic grouping

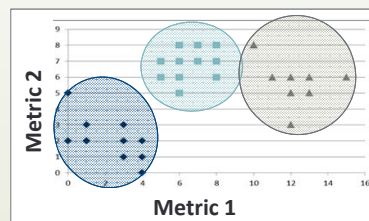

15 | brattle.com

Clustering Metrics

Group Networks/Load Areas with similar cost and peak characteristics

- Will the cluster require investments due to load growth?
 - Will similar investments result in similar costs?
 - What type of investment might be needed?
 - Historical Network/Load Area level data availability to prevent creating clusters without cost data
- Similar Costs for Clusters
- Similar Profiles to Reduce Network/Load Area Peak Load

Investment Requirements/Cost of Investments

- Substation upgrade year
- % feeders projected to exceed rating
- 10-year peak load CAGR
- LSRV status
- Network/Load Area type
- Borough grouping

Investment Type/Load Shape Proxies

- Normalized peak day load shape cluster
- Temperature Sensitivity
- Commercial System Relief Program window (CSRP)

Clustering Metrics: Detailed Description

Metric	Detailed Description
Substation Upgrade Year	Year of upgrade identified in Consolidated Edison planning documents
% Feeders Projected to Exceed Normal Rating	Proxy for investment rather than planned investments; approach to be generally aligned with distribution engineering approach to reinforcements
10-Year Peak CAGR	10 year forecast using peak load forecast accounting for all DR/DG
LSRV Status	Yes or no; currently used as a check to facilitate comparison of consistency
Network/Load Area Type	Load area type (radial or network)
Borough Grouping	(1) Manhattan; (2) Bronx, Brooklyn, and Queens; (3) Westchester & Staten Island
Normalized Peak Day Load Shape Cluster	Grouping of Network/Load Area load shapes into one of three characteristic shapes (more detail next slide)
Temperature Sensitivity	Correlation coefficient and predictive power of regression between peak load and temperature
Commercial System Relief Program	Indicates peaking time

Clustering Metrics: Load Shape

Characteristic load shapes provide a proxy for the combined factors of load factor, timing of peak, and length of peak

- All Networks/Load Areas grouped into 3 types using normalized peak-day load shapes
- Grouping may serve as a proxy for similar types of investment requirements/types
- Clustering performed using statistical k-means approach

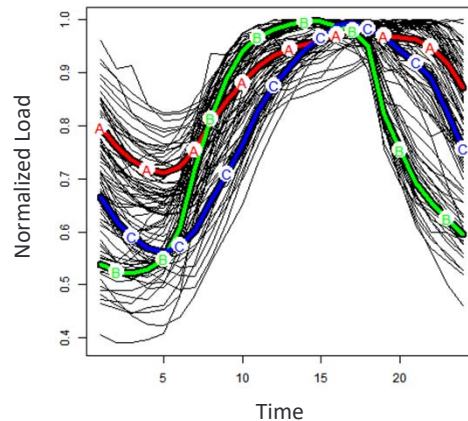

MCCOS Next Steps

- Refinement of clustering metrics to ensure consistency with the Company's engineering planning approaches
- Comparison of clustering approaches
- Finalization of historical sample project data sample and projected investments
- Projection of timing for Network/Load Area investments
- Comparison of initial marginal costs to LSRV and prior MCs

Discussion



Privileged and Confidential

20 | brattle.com

Team Biographies

The Brattle Group

PHIL HANSER
Principal | Boston



Mr. Hanser is a principal of The Brattle Group and has over thirty-five years of consulting and litigation experience in the energy industry. He has appeared as an expert witness before the U.S. Federal Energy Regulatory Commission (FERC), state public utility commissions, environmental agencies, Canadian utility boards, as well as arbitration panels, and in federal and state courts.

BRUCE TSUCHIDA
Principal | Boston



Mr. T. Bruce Tsuchida has over 25 years of experience in utility operations, power market analysis, and new technology development for both domestic and international markets. He has been leading several studies of renewable integration and the associated changes in utility business models for island utilities where the distinction between transmission and distribution does not exist.

PEARL DONOHOO-VALLETT
Associate | Washington D.C.



Dr. Pearl Donohoo-Vallett has expertise clean energy policy, utility regulatory ratemaking, and transmission planning. She has familiarity with the New York power system and related policies through prior modeling on the New York City 80X50 project and the New York Clean Energy Standard.

EnerNex

JENS SCHOENE
Director of Research Studies



Dr. Schoene has over 10 years power industry experience and has led and participated in studies on integration of renewable generation in distribution systems; transients, harmonics, and TOVs in wind plants and other power systems; power quality measurements; and inductive coupling in distribution systems.

MUHAMMAD HUMAYUN
Senior Consultant



Dr. Humayun's expertise includes power systems planning, operation, and control; reliability studies, substations, load flow calculation methods, short circuit analysis, and contingency analysis; distribution system planning, operation, and control; protective relaying; and optimization methods applied to power system problems.

VADIM ZHEGLOV
Senior Consultant



Mr. Zheglov has performed studies that identify integration impacts of renewable energy generation on power systems. His expertise is in modeling simulations and integration cost analysis. Mr. Zheglov also performs on-site field measurements on operating power systems ranging from solar and wind power plants to integrated backup power supplies.

Privileged and Confidential

21 | brattle.com

INTERIM STAKEHOLDER MEETING PRESENTATION (OCTOBER 23, 2017)

Consolidated Edison Marginal Cost Study

Study Framework

PRESENTED TO

CECONY Stakeholders

PRESENTED BY

Philip Hanser
Bruce Tsuchida
Pearl Donohoo-Vallett
Jens Schoene

October 23, 2017



Copyright © 2017 The Brattle Group, Inc.

Agenda

Project Overview

Calculation Methodology

Clustering

Illustrative Calculation

Project Overview

Project Overview

Consolidated Edison has tasked Brattle & EnerNex (Brattle Team) with developing a locational Marginal Cost-based Cost of Service Study (MCCOS) approach to support the Value of Distributed Energy Resources (VDER) proceedings

- The Brattle team will be developing an approach for more granular (Network/Load Area level) marginal costs
- Prior study provided an average system-wide value, which the Commission determined was insufficient to support the Reforming the Energy Vision (REV) goals
- The resulting MCCOS will allow the company to set values for multiple Location-Specific Relief Value areas (LSRVs), replacing the current binary “stretch” and “squeeze” approach

MCCOS will focus on marginal costs due to incremental load growth and only assume traditional wires options

- The focus on traditional wires options provides a baseline for comparison to non-wires solutions
- A separate cost-benefit analysis can then be performed for non-wires solutions

System Planning Approach

We propose to follow a System Planning approach to develop marginal costs for several clusters of Networks/Load Areas

- The basic question in calculating electric marginal costs is “What is the least cost means of meeting an increase in demand without jeopardizing the level of reliability?”
- The system planning approach examines a range of available options to meet an increase in load while maintaining the same level of reliability and is aligned with engineering practices
 - Answers the question “How would a system planner respond to a change in load?”
 - Marginal costs are the difference between maintaining the current system and the system configured to meet the additional demand

Consolidated Edison System

Balancing geographic granularity, data availability, and mismatches in planning timelines, Consolidated Edison’s (the Company’s) 65 networks and 19 non-networked areas will be clustered in order to produce cost estimates for groups of Networks/Load Areas

- The Company’s system is not easily separable for analysis due to its mix of radial and networked areas
- Clustering allows analysis by making use of historical project data approximation of projected investments when specific planning data is not available

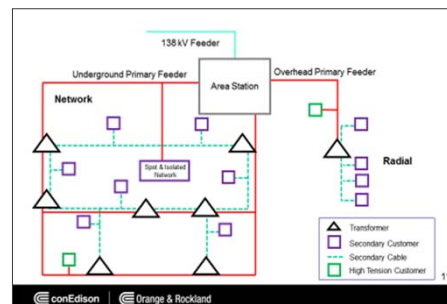

Eight Cost Centers

Past Consolidated Edison studies have used eight cost centers; these cost centers need to be assigned/allocated to Network/Load Area clusters

- Transmission Costs
[higher electrical level than area substation – serves multiple]
 - Switching Station Costs – Transmission functionality
[higher electrical level than area substation – serves multiple]
 - Switching Station Costs – Substation functionality
[higher electrical level than area substation – serves multiple]
 - Area Substation and Sub-transmission Costs
[area substation]
 - Primary Feeder Costs
[network/load area]
 - Distribution Transformer Costs
[network/load area]
 - Secondary Cable Costs
[network/load area]
 - Customer-related costs: services, metering, customer accounting/customer service
- Diagram annotations:
- A bracket groups the first three items (Transmission, Switching Station - Transmission, and Switching Station - Substation) with the label "Split among Area Subs."
 - A bracket groups the last three items (Primary Feeder, Distribution Transformer, and Secondary Cable) with the label "Networks/Load Areas".
 - A bracket groups the last two items (Distribution Transformer and Secondary Cable) with the label "Split among Networks/Load Areas".
 - A red dashed box highlights the items "Area Substation and Sub-transmission Costs", "Primary Feeder Costs", "Distribution Transformer Costs", and "Secondary Cable Costs".
 - The word "Focus" is written in red next to the red dashed box.

Calculation Methodology

General Approach of Calculation

$$\text{Marginal Cost (\$/kW)} = \text{NPV} \left\{ \frac{\text{Net Cost}}{\text{Capacity Increase}} \right\}$$

Net Cost = Investment Cost – Replaced Asset Residual Value

Capacity Increase = Capacity Increase at Contingency Ratings

- Marginal costs will mean the net cost, i.e., new investment cost net of the residual value of the asset that is being replaced/retired to accommodate the increase in load
- Cost will be calculated on an Net Present Value (NPV) basis
- Model/Calculation will cover a ten year period starting 2018 through 2027
- MCCOS model will be developed to perform calculation at the Network/Load Area level granularity
- Inclusion of Net Cost calculation (removal of replaced asset residual value) will decrease marginal costs

Investment Costs

Area substation costs will be based on the Company's Load Area Relief Plan

- Provides area substation projects and timing on a 10-year time horizon

Network/Load Area level costs will be based on historical sampling and budgeting for future years

- Network/Load Area level costs include primary network, transformer, and secondary cable cost centers
- Historical sample spans approximately 3 years (2015-2017)
- Data includes projects to accommodate increasing load from existing customers and increasing load from new customers
- Timing and size of investments by cluster will be based on a combination of budget forecasts and potential needs

Residual Value Calculation (1/2)

The residual values of replaced assets (when applicable) will be estimated using Consolidated Edison's historical data

- Area Substation level and Network/Load Area level projects are divided into two groups: those with asset replacement and those without asset replacement (new assets only)
- Estimated values for replaced assets will be used based on FERC-account level information
- Residual value will be proportional to average age of asset at replacement

$$\text{Replaced Residual Asset Value (\$)} = \text{New Asset Cost (\$)} \times \text{Approx. Value Remaining (\%)}$$

Residual Value Calculation (2/2)

- The estimated percentage of residual value remaining will be derived from the mapping of FERC-level accounts to the Company's cost centers

$$\text{Approx. Value Remaining (\%)} = \frac{\text{Reproduction Cost Net Depreciation}}{\text{Reproduction Cost}}$$

- Residual value will be proportional to average age of asset at replacement
- Range of residual value remaining is ~5-7% and will reduce marginal costs by approximately this same range as residual values are subtracted from costs

Underground Conductors Average % Remaining Value

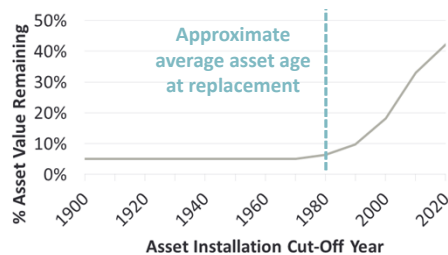

Clustering

Review: Why Cluster?

- The proposed MCCOS approach will calculate marginal costs at a Network/Load Area level rather than at the system level; as such, the approach must accommodate features of network/load area level investments :
 - Investments for Network/Load Area level cost centers (primary, transformer, and secondary) are determined on a **~1-3 year time horizon**; marginal cost study considers **10 year time horizon**
 - The available historical sample (3 years) does not provide estimates for all networks; the proposed approach addresses these issues through **clustering of networks**
- The goal is to produce groupings with **similar cost characteristics**

Approach to Clustering

Clustering is an iterative process of selecting appropriate metrics and then clustering Networks/Load Areas according to those metrics

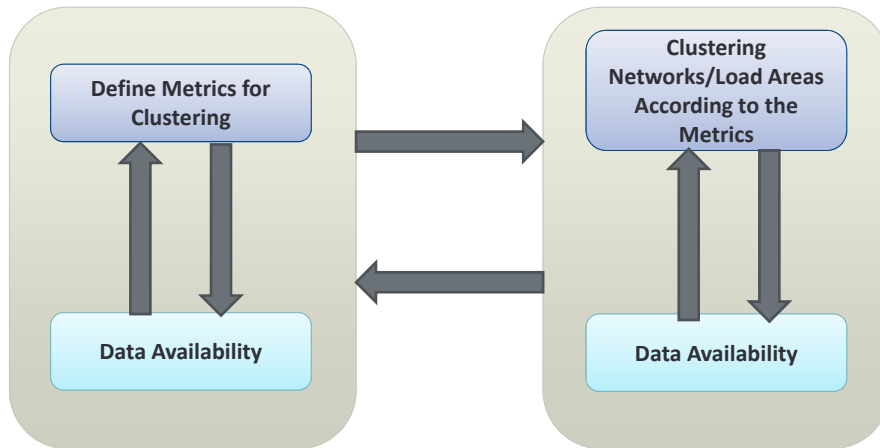

Privileged and Confidential

14 | brattle.com

Network/Load Area Clustering Approaches

- Combinations of metrics for each Network/Load Area can be clustered in several ways
- We have selected two approaches for comparison and potential combination

Hierarchical

Groups load areas using a “tree” approach, allowing grouping to follow “most-to-least” importance of metrics

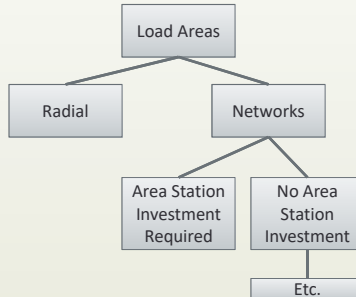

Privileged and Confidential

Statistical (k-means)

Creates an optimal number of groups based on multitude of numbers – does not require ranking of metrics and allows for more holistic grouping

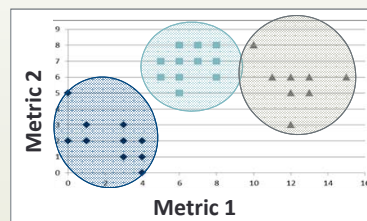

15 | brattle.com

Clustering Metrics

Group Networks/Load Areas with similar cost and peak characteristics

- Will the cluster require investments due to load growth?
 - Will similar investments result in similar costs?
 - What type of investment might be needed?
 - Historical Network/Load Area level data availability to prevent creating clusters without cost data
- Similar Costs for Clusters
- Similar Profiles to Reduce Network/Load Area Peak Load

Investment Requirements/Cost of Investments

- Substation upgrade year
- % feeders projected to exceed rating
- 10-year peak load CAGR
- Network/Load Area type
- Borough grouping

Investment Type/Load Shape Proxies

- Normalized peak day load shape cluster
- Temperature Sensitivity
- Commercial System Relief Program window (CSRP)

Clustering Metrics: Detailed Description

Metric	Detailed Description
Substation Upgrade Year	Year of upgrade identified in Consolidated Edison planning documents
% Feeders Projected to Exceed Normal Rating	Proxy for investment rather than planned investments; approach to be generally aligned with distribution engineering approach to reinforcements
10-Year Peak CAGR	10 year forecast using peak load forecast accounting for all DR/DG
Network/Load Area Type	Load area type (radial or network)
Borough Grouping	(1) Manhattan; (2) Bronx, Brooklyn, and Queens; (3) Westchester & Staten Island
Normalized Peak Day Load Shape Cluster	Grouping of Network/Load Area load shapes into one of three characteristic shapes (more detail next slide)
Temperature Sensitivity	Correlation coefficient and predictive power of regression between peak load and temperature
Commercial System Relief Program	Indicates peaking time

Clustering Metrics: Load Shape

Characteristic load shapes provide a proxy for the combined factors of load factor, timing of peak, and length of peak

- All Networks/Load Areas grouped into 3 types using normalized peak-day load shapes
- Grouping may serve as a proxy for similar types of investment requirements/types
- Clustering performed using statistical k-means approach

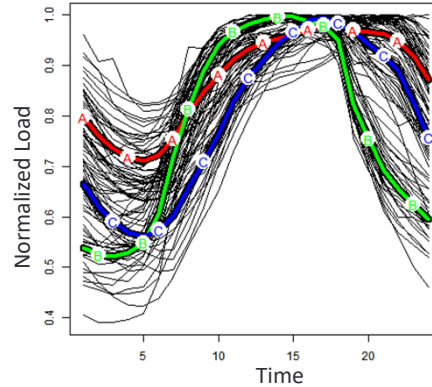

Cluster	Median% Residential	# Networks
A	45 [range: 0-65]	42
B	25 [range: 0-45]	22
C	50 [range: 25-80]	18

Illustrative Calculation

Example Network/Load Area Calculation

The hypothetical network presented below is a preliminary demonstrative calculation; it should not be interpreted as an “average” value or anticipated result of the final study. The \$/kW investment costs are based on actual historical or projected projects.

The network is characterized by:

- No required work above the Area Substation/Subtransmission level
- Network transfer in 2022 at Area Substation/Subtransmission level
- One primary network upgrade (2021)
- Two secondary cable upgrades (one each in 2021 and 2025)

Asset Costs by Cost Center (2018 \$/kW)

Cost Center	2018	2019	2020	2021	2022	2023	2024	2025	2026	2027
Transmission	\$ -	\$ -	\$ -	\$ -	\$ -	\$ -	\$ -	\$ -	\$ -	\$ -
Switching Station (Transmission)	\$ -	\$ -	\$ -	\$ -	\$ -	\$ -	\$ -	\$ -	\$ -	\$ -
Switching Station (Substation)	\$ -	\$ -	\$ -	\$ -	\$ -	\$ -	\$ -	\$ -	\$ -	\$ -
Area Station	\$ -	\$ -	\$ -	\$ -	\$ 390	\$ -	\$ -	\$ -	\$ -	\$ -
Primary Network	\$ -	\$ -	\$ -	\$ 24	\$ -	\$ -	\$ -	\$ -	\$ -	\$ -
Transformer	\$ -	\$ -	\$ -	\$ -	\$ -	\$ -	\$ -	\$ -	\$ -	\$ -
Secondary Cable	\$ -	\$ -	\$ -	\$ 304	\$ -	\$ -	\$ -	\$ 304	\$ -	\$ -

Privileged and Confidential

20 | brattle.com

Primary Network Calculation Example (I)

1. Calculate Net Cost

$$\text{Investment Cost } \$1.7\text{M} - \text{Average \% Residual Value Remaining } 6\% \times \$1.7\text{M} = \text{Net Cost } \$1.6\text{M}$$

2. Divide by Incremental Capacity

$$\frac{\text{Project Total Capacity } 238 \text{ MW} - \text{Existing Capacity } 167 \text{ MW}}{\text{Incremental Capacity } 71 \text{ MW}} = \frac{\$1.6\text{M}}{\text{Incremental Capacity } 71 \text{ MW}} = \$22/\text{kW}$$

Privileged and Confidential

21 | brattle.com

Primary Network Calculation Example (II)

3. Annualize and Load

$$= \$22/\text{kW} \times \text{Loadings} + \text{O\&M} +$$

Revenue Requirement for Working Capital

$$= \$3.2/\text{kW-year}$$

4. Calculate NPV

$$\text{MC} = \text{NPV} (\$2.7 \text{ \$/kW-year in 2021})$$

$$= \$2.6/\text{kW-year}$$

Example Network/Load Area Marginal Costs

The fully loaded marginal costs vary over time due to the date of investments and will differ depending on the type and timing of investments required within each cluster

For the hypothetical network shown below:

- Highest marginal cost is in earliest years due to ability to offset projects and time value of money
- Largest marginal cost contribution from secondary cable cost center

Marginal Costs by Cost Center (2018 \$/kW)

Cost Center	2018	2019	2020	2021	2022	2023	2024	2025	2026	2027
Transmission	\$ -	\$ -	\$ -	\$ -	\$ -	\$ -	\$ -	\$ -	\$ -	\$ -
Switching Station (Transmission)	\$ -	\$ -	\$ -	\$ -	\$ -	\$ -	\$ -	\$ -	\$ -	\$ -
Switching Station (Substation)	\$ -	\$ -	\$ -	\$ -	\$ -	\$ -	\$ -	\$ -	\$ -	\$ -
Area Station	\$ 42	\$ 42	\$ 42	\$ 42	\$ 42	\$ -	\$ -	\$ -	\$ -	\$ -
Primary Network	\$ 3	\$ 3	\$ 3	\$ 3	\$ -	\$ -	\$ -	\$ -	\$ -	\$ -
Transformer	\$ -	\$ -	\$ -	\$ -	\$ -	\$ -	\$ -	\$ -	\$ -	\$ -
Secondary Cable	\$ 62	\$ 62	\$ 62	\$ 62	\$ 27	\$ 27	\$ 27	\$ 27	\$ -	\$ -
Total Marginal Cost	\$106.10	\$106.10	\$106.10	\$106.10	\$ 68.58	\$ 26.58	\$ 26.58	\$ 26.58	\$ -	\$ -

MCCOS Next Steps

- Refinement of clustering metrics to ensure consistency with the Company's engineering planning approaches
- Comparison of clustering approaches
- Finalization of historical sample project data sample and projected investments
- Projection of timing for Network/Load Area investments

Discussion



Team Biographies

The Brattle Group

PHIL HANSER
Principal | Boston



Mr. Hanser is a principal of The Brattle Group and has over thirty-five years of consulting and litigation experience in the energy industry. He has appeared as an expert witness before the U.S. Federal Energy Regulatory Commission (FERC), state public utility commissions, environmental agencies, Canadian utility boards, as well as arbitration panels, and in federal and state courts.

BRUCE TSUCHIDA
Principal | Boston



Mr. T. Bruce Tsuchida has over 25 years of experience in utility operations, power market analysis, and new technology development for both domestic and international markets. He has been leading several studies of renewable integration and the associated changes in utility business models for island utilities where the distinction between transmission and distribution does not exist.

PEARL DONOHOO-VALLETT
Associate | Washington D.C.



Dr. Pearl Donohoo-Vallett has expertise clean energy policy, utility regulatory ratemaking, and transmission planning. She has familiarity with the New York power system and related policies through prior modeling on the New York City 80X50 project and the New York Clean Energy Standard.

JENS SCHOENE
Director of Research Studies



Dr. Schoene has over 10 years power industry experience and has led and participated in studies on integration of renewable generation in distribution systems; transients, harmonics, and TOVs in wind plants and other power systems; power quality measurements; and inductive coupling in distribution systems.

EnerNex

MUHAMMAD HUMAYUN
Senior Consultant



Dr. Humayun's expertise includes power systems planning, operation, and control; reliability studies, substations, load flow calculation methods, short circuit analysis, and contingency analysis; distribution system planning, operation, and control; protective relaying; and optimization methods applied to power system problems.

VADIM ZHEGLOV
Senior Consultant



Mr. Zheglov has performed studies that identify integration impacts of renewable energy generation on power systems. His expertise is in modeling simulations and integration cost analysis. Mr. Zheglov also performs on-site field measurements on operating power systems ranging from solar and wind power plants to integrated backup power supplies.

Privileged and Confidential

PRESENTATION TO THE NEW YORK DEPARTMENT OF PUBLIC SERVICE STAKEHOLDER MEETING (FEBRUARY 9, 2018)

Con Edison Marginal Cost Study Overview

Value Stack and Rate Design Working Groups Meeting

PRESENTED TO

STATE OF NEW YORK PUBLIC SERVICE COMMISSION

PRESENTED BY

Philip Q Hanser
T. Bruce Tsuchida
Lynn Zhang

February 9, 2018

THE **Brattle** GROUP

Copyright © 2017 The Brattle Group, Inc.

Disclaimer

This presentation, designed for an interactive meeting with the Value Stack and Rate Design Working Groups stakeholders, is intended to assist in developing an informed view on the marginal cost-based cost of study approach being developed.

This presentation and associated meeting are not meant or permitted to be a substitute for the exercise of any stakeholder's own business judgment.

The Brattle Group cannot, and does not, accept liability under any theory for losses suffered, whether direct or consequential, arising from any reliance on this presentation, and cannot be held responsible if any conclusions drawn from this presentation should prove to be inaccurate.

Study Overview

Study Scope: Develop a locational Marginal Cost-based Cost of Service Study (MCCOS) approach in response to Rate Case Order 16-E-0060. Results can be used to support the Value of Distributed Energy Resources (VDER) proceedings.

- Balancing geographic granularity, data availability, and mismatches in planning timelines, Con Edison's 65 networked and 19 non-networked areas (84 Load Areas) will be clustered in order to produce cost estimates for groups of Load Areas.
 - The Con Edison system is not easily separable for analysis due to its mix of radial and networked areas.
 - Grouping can be used to approximate and/or augment data where data for any Cost Center / Load Area is not available.
 - Grouping will also help avoid unnecessary differentiation among the Load Areas.



MCCOS will focus on marginal costs due to incremental load growth and only assume traditional wires options.

- The focus on traditional wires options provides a baseline for comparison to non-wires solutions.
- A separate cost-benefit analysis can then be performed for non-wires solutions.

Con Edison of New York
 - 10,000 miles of underground transmission and distribution lines
 - 10,000 miles of overhead transmission and distribution lines
 - 4,000 miles of gas mains
 - 100 miles of steam mains and lines
 - 12 million electric customers
 - 1.1 million gas customers
 - 1,000 power substations

Orange and Redland Utilities
 - 1,000 miles of underground transmission and distribution lines
 - 1,000 miles of overhead transmission and distribution lines
 - 1,000 miles of gas mains
 - 200,000 electric customers
 - 100,000 gas customers
 - 100,000 gas customers

Source: http://media.corporate-ir.net/media_files/nys/ed/10k/Financial10K2005ED.htm

General Approach of Calculation

$$\text{Marginal Cost (\$/kW)} = \frac{\text{NPV(Net Cost)}}{\text{NPV(Capacity Increase)}}$$

Net Cost = Investment Cost – Replaced Asset Residual Value
Capacity Increase = Capacity Increase at Contingency Ratings

- Marginal costs (MC) will mean the net cost, i.e., new investment cost net of the residual value of the asset that is being replaced/retired to accommodate the increase in load.
- Cost will be calculated on an Net Present Value (NPV) basis.
- Calculation will cover a ten year period starting 2018 through 2027.
- MCCOS model will be developed to perform calculation at the Load Area level granularity.
- The residual values of replaced assets (when applicable) will be estimated using Con Edison's historical data.
 - All projects are divided into two groups: those with asset replacement and those without asset replacement (new assets only).
 - Estimated values for replaced assets will be used based on FEREC-account level information.
 - Residual value will be proportional to average age of asset at replacement.

Underground Conductors Average % Remaining Value

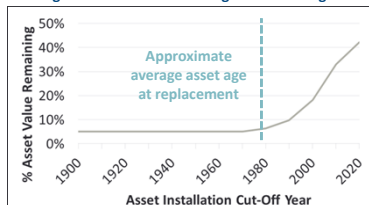

Source: Brattle analysis of Con Edison FEREC account data

Cost Centers

MCs are calculated by Cost Centers; each assigned/allocated to Load Area clusters.

1. High Voltage System Costs (Transmission, Switching Stations etc.)
 2. Load Area Substation and Sub-transmission Costs
 3. Primary Feeder Costs
 4. Distribution Transformer Costs
 5. Secondary Cable Costs
- } Split among Load Areas
↓
} By Load Areas

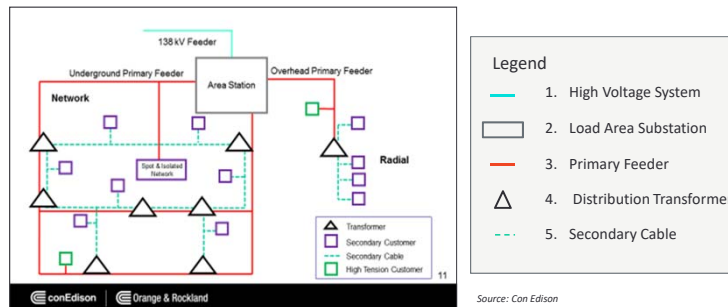

4 | brattle.com

Investment Assumptions

High Voltage Systems and Load Area Substation and Sub-transmission Costs and timing based on the Con Edison's Load Area Relief Plan.

- Provides area substation projects and timing on a 10-year time horizon.

Primary Feeder, Transformer, and Secondary Cable Costs are based on historical sampling.

- Weighted Mean cost values taken from historical sample spanning over 3 years (2015-2017).
- Data includes projects to accommodate increasing load from existing customers and increasing load from new customers.
- Historical samples are grouped by boroughs* (Borough Groupings).

Primary Feeder upgrade timing is based on anticipated load growth for future years.

- Loading of each feeder is assumed to grow at the load growth rate of its corresponding Load Area. Upgrade needs occur when the feeder loading exceeds its normal rating.

Transformer and Secondary Cable upgrade timing is based on historical sampling.

- Frequency of upgrades are based on historical observations (e.g., 15 projects over a 3 year period for a Borough Groupings that contains 10 Load Areas indicates 0.5 upgrades per year per Load Area, or one upgrade per Load Area every other year).
- Historical sample spans approximately 3 years (2015-2017).

* The Con Edison New York service territory includes 5 boroughs (Manhattan, the Bronx, Queens, Brooklyn, and Staten Island), and Westchester. In this study, Westchester is also referred to as a "borough" for convenience.

5 | brattle.com

Clustering – Potential Supplemental Subgrouping

The proposed MCCOS approach will calculate marginal costs at Load Area levels rather than at the system level; as such, the approach must accommodate features of Load Area level investments:

- Investments for the lower voltage level Cost Centers (Primary Feeders, Transformers, and Secondary Cables) are planned on a ~1-3 year time horizon while MCCOS considers 10 year time horizon.
- The select historical sample (3 years) does not provide estimates for all networks and the proposed approach addresses these issues through clustering of networks.

The goal is to produce groupings with similar cost characteristics.

- We may additionally use similarity of load characteristics with groups as a means to subgroup, if necessary.

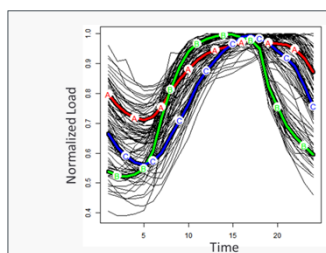

Clustering Approach Example - Load Shapes

Characteristic load shapes provide a proxy for the combined factors of load factor, timing of peak, and length of peak.

Cluster	Median% Residential	# Networks
A	45 [range: 0-65]	42
B	25 [range: 0-45]	22
C	50 [range: 25-80]	18

Please note that this load shapes approach is listed as an example and may or may not be used for actual clustering.

6 | brattle.com

Illustrative Calculation Example

Example: Asset replacement in 2021

- New asset capacity: 238 MW
- Existing asset capacity: 167 MW
- New asset cost: \$1.7 million
- Existing asset residual value: 6% of new asset

1. Calculate Net Cost

$$\text{Investment Cost } \$1.7\text{M} - \text{Average \% Residual Value Remaining } (\$1.7\text{M} \times 6\%) = \text{Net Cost } \$1.6\text{M}$$

2. Divide by Incremental Capacity

$$\frac{\text{Project Total Capacity } 238\text{ MW} - \text{Existing Capacity } 167\text{ MW}}{\text{Incremental Capacity } 71\text{ MW}} = \frac{\text{Net Cost } \$1.6\text{M}}{71\text{ MW}} = \$22/\text{kW}$$

3. Annualize and Load

$$\begin{aligned} \text{Total Annualized Cost} &= \text{Annual Investment Cost (incl. G\&A)} + \text{O\&M (incl. G\&A)} + \text{Revenue Requirement for Working Capital (incl. G\&A)} \\ &= \text{Investment Cost} \times \text{Economic Carrying Charge} \times (1 + \text{Plant G\&A}) \times (1 + \text{Common Plant}) \\ &\quad + \text{Investment Cost} \times \text{Historical O\&M per } \$ \text{ Cost Center} \times (1 + \text{Non-Plant G\&A}) \\ &\quad + \text{Investment Cost} \times \text{Revenue Requirement for Working Capital} \times (1 + \text{Plant G\&A}) \times (1 + \text{Plant Loading}) \times \text{Working Capital/Total Plant} \times \text{Return Rate} \end{aligned}$$

$$3. \text{ Total Annualized Cost} = 2.65 + 0.45 + 0.06 = \$3.16$$

4. Calculate NPV

$$\begin{aligned} \text{MC in 2018} &= \text{NPV } (\$3.16 \text{ } \$/\text{kW-year in 2021}) \\ \text{MC in 2019} &= \$2.58/\text{kW-year} \\ \text{MC in 2020} &= \$2.76/\text{kW-year} \\ \text{MC in 2021} &= \$2.95/\text{kW-year} \\ &= \$3.16/\text{kW-year} \end{aligned}$$

7 | brattle.com

Discussion



8 | brattle.com

About Brattle

The Brattle Group provides consulting and expert testimony in economics, finance, and regulation to corporations, law firms, and governments around the world. We aim for the highest level of client service and quality in our industry.

We are distinguished by our credibility and the clarity of our insights, which arise from the stature of our experts, affiliations with leading international academics and industry specialists, and thoughtful, timely, and transparent work. Our clients value our commitment to providing clear, independent results that withstand critical review.

9 | brattle.com

Brattle Practices

ENERGY & UTILITIES

- Competition & Market Manipulation
- Distributed Energy Resources
- Electric Transmission
- Electricity Market Modeling & Resource Planning
- Energy Litigation
- Environmental Policy, Planning and Compliance
- Finance and Ratemaking
- Gas/Electric Coordination
- Market Design
- Natural Gas & Petroleum
- Nuclear
- Renewable & Alternative Energy

LITIGATION

- Accounting
- Analysis of Market Manipulation
- Antitrust/Competition
- Bankruptcy & Restructuring
- Big Data & Document Analytics
- Commercial Damages
- Environmental Litigation & Regulation
- Intellectual Property
- International Arbitration
- International Trade
- Labor & Employment
- Mergers & Acquisitions Litigation
- Product Liability
- Securities & Finance
- Tax Controversy & Transfer Pricing
- Valuation
- White Collar Investigations & Litigation

INDUSTRIES

- Electric Power
- Financial Institutions
- Natural Gas & Petroleum
- Pharmaceuticals & Medical Devices
- Telecommunications, Internet, and Media
- Transportation
- Water

Brattle Offices



FINAL STAKEHOLDER MEETING PRESENTATION (TO BE ADDED)

BOSTON
NEW YORK
SAN FRANCISCO
WASHINGTON
TORONTO
LONDON
MADRID
ROME
SYDNEY

THE **Brattle** GROUP